

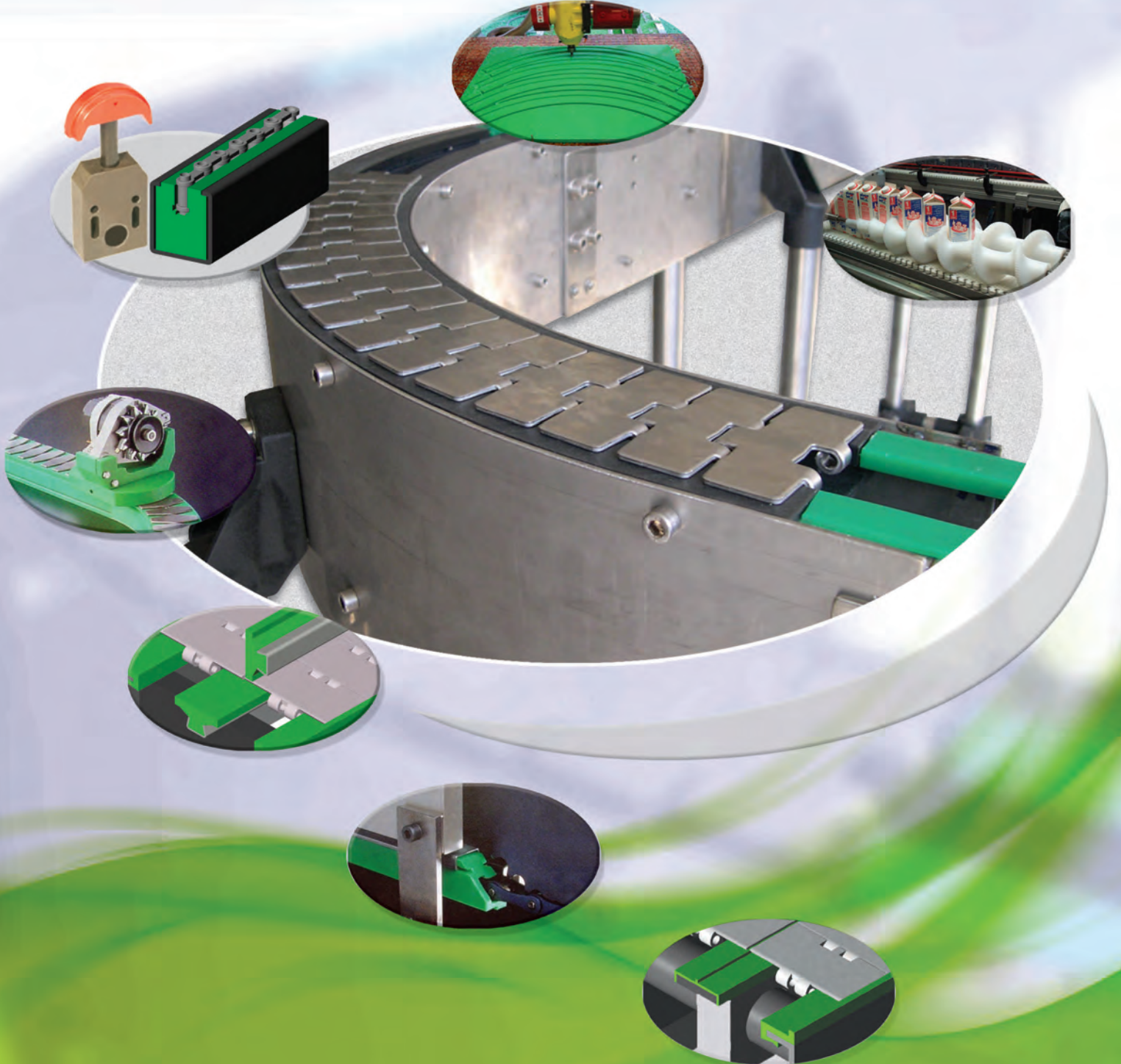

ÇAĞRI[®]
ENDÜSTRİ A.Ş.

ALHAN[®]

SÜRTÜNME PROFİLLERİ ve ZİNCİR KIZAKLARI
FRICION GUIDES & ROLLER CHAIN GUIDES



2015

www.alhan-cagri.com

CERTIFICATE

QUALITY MANAGEMENT
 ÇAĞRI ENDÜSTRİ MALLARI PAZARLAMA
 YATIRIM SANAYİ VE TİCARET
 A.Ş.
 Company
 Davutpaşa Cad. No:14 Kat:2
 Topkapı - İstanbul / TÜRKİYE
 at address:
 DESIGN, PRODUCTION AND SALES OF
 CONVEYOR PARTS, MACHINE ELEMENTS
 AND ENGINEERING PLASTICS
 EA 14.17
 at scope
 perform the quality management system;
ISO 9001:2008
 (the complete of the standard was determined)

Date First Registered: 02.03.2010
 Date Certificate Issued: 01.03.2011
 Period of Registration: 3 Years
 Date Certificate Expires: 29.02.2012
 Certificate No: 01/10077/02-08

Approver:



SERTİFİKA

KALİTE YÖNETİMİ
 ÇAĞRI ENDÜSTRİ MALLARI PAZARLAMA
 YATIRIM SANAYİ VE TİCARET
 A.Ş.
 Kuruluşun
 Davutpaşa Cad. No:14 Kat:2
 Topkapı - İstanbul / TÜRKİYE
 adresinde,
 KONVEYÖR PARÇALARI MÜHENDİSLİK
 PLASTİKLERİ VE MAKİNE ELEMANLARI
 TASARIM ÜRETİM SATIŞI
 EA 14.17
 kapsamında
 kalite yönetim sistemi yürürlüğe koyuldu.
ISO 9001:2008
 standart taleplerinin yerine getirildiği belirlenmiştir.

İlk Yayın Tarihi: 02.03.2010
 Yayın Tarihi: 01.03.2011
 Geçerlilik Periyodu: 3 Yıl
 Çaprazlama Tarihi: 29.02.2012
 Sertifika Numarası: 01/10077/02-TR

Onay:



ZERTİFİKAT

QUALITÄTSMANAGEMENT
 ÇAĞRI ENDÜSTRİ MALLARI PAZARLAMA
 YATIRIM SANAYİ VE TİCARET
 A.Ş.
 bei der Adresse:
 Davutpaşa Cad. No.14 Kat:2
 Topkapı - İstanbul / TÜRKİYE
 hat für den Geltungsbereich:
 ENTWICKLUNG, HERSTELLUNG UND VERKAUF
 VON KOMPONENTEN AUS METALL UND
 KUNSTSTOFF FÜR TRANSPORT- UND
 LAGERTECHNIK
 EA 14.17
 Scope
 ein Managementsystem eingeführt,
ISO 9001:2008
 die die Normanforderungen erfüllt.

Erstausgabe: 02.03.2010
 Gültig vom: 01.03.2011
 Gültigkeitsperiode: 3 Jahre
 Gültig bis: 29.02.2012
 Zertifikat Nr: 01/10077/02-08

Bestätigung:



MARKA TESCİL BELGESİ

T.C. TÜRK PATENT ENSTİTÜSÜ

Marka No: 2003141
 Çeşit: TİCARET



Marka Sahibi: ÇAĞRI ENDÜSTRİ MALLARI PAZARLAMA YATIRIM SANAYİ VE TİCARET ANONİM ŞİRKETİ
 Tülaylı: TÜRKİYE CUMHURİYETİ
 Adres: Maltepe, Emisalelli Cad. No:22 BAYRAMPAŞA İSTANBUL
 Etiler: 35067
 Riviz: Riviz Lisans İşleticisi

Markaların Korunması Hakkında 506 Sayılı Kanun Hükmünde Kararnameyle 02/03/2008 Tarihinden İtibaren ON YIL süreyle tescil edilmiştir.

Doç. Dr. Yusuf BALCI
 Enstitü Başkanı c.
 T.C. TÜRK PATENT ENSTİTÜSÜ

MARKA TESCİL BELGESİ

T.C. TÜRK PATENT ENSTİTÜSÜ

Marka No: 200215474
 Çeşit: İsimler



Marka Sahibi: ÇAĞRI ENDÜSTRİ MALLARI PAZARLAMA YATIRIM SANAYİ VE TİCARET ANONİM ŞİRKETİ
 Tülaylı: TÜRKİYE CUMHURİYETİ
 Adres: Maltepe, Emisalelli Cad. No:22 BAYRAMPAŞA İSTANBUL
 Etiler: 35, 46, 42
 Riviz: Riviz

Markaların Korunması Hakkında 506 Sayılı Kanun Hükmünde Kararnameyle 02/03/2008 Tarihinden İtibaren ON YIL süreyle tescil edilmiştir.

Doç. Dr. Yusuf BALCI
 Enstitü Başkanı c.
 T.C. TÜRK PATENT ENSTİTÜSÜ

ENDÜSTRİYEL TASARIM TESCİL BELGESİ

T.C. TÜRK PATENT ENSTİTÜSÜ

TESCİL NO:2002 02347
 TEKLİ

Tasarım Sahibi: ÇAĞRI ENDÜSTRİ MALLARI PAZARLAMA YATIRIM SANAYİ VE TİCARET ANONİM ŞİRKETİ
 Tülaylı: TÜRKİYE CUMHURİYETİ
 Adres: Maltepe, Emisalelli Cad.No:22 Bayrampaşa İSTANBUL
 Etiler: Maltepe Arayış

Endüstriyel Tasarımların Korunması Hakkında 554 Sayılı Kanun Hükmünde Kararnameyle 02/03/2003 Tarihinden İtibaren İKİ YIL süreyle tescil edilmiştir.

Doç. Dr. Yusuf BALCI
 Enstitü Başkanı c.
 T.C. TÜRK PATENT ENSTİTÜSÜ

FAYDALI MODEL BELGESİ

T.C. TÜRK PATENT ENSTİTÜSÜ

No: TR 2003 00089 Y

Bu belge, 551 sayılı Patent Hukukunun Kararname Hükümlerinde Kanun Hükmünde Kararname'nin 162 nci maddesi uyarınca 27/01/2003 tarihinden itibaren 10 yıl süre ile verilmiştir.

Doç. Dr. Yusuf BALCI
 Enstitü Başkanı c.
 T.C. TÜRK PATENT ENSTİTÜSÜ

ÇAĞRI[®]
ENDÜSTRİ A.Ş.

ALHAN[®]

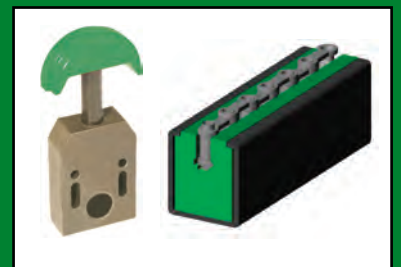
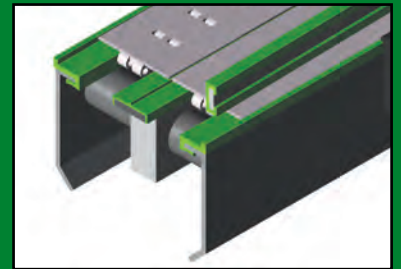
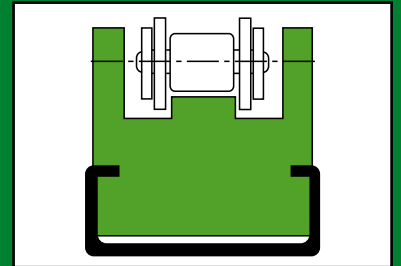
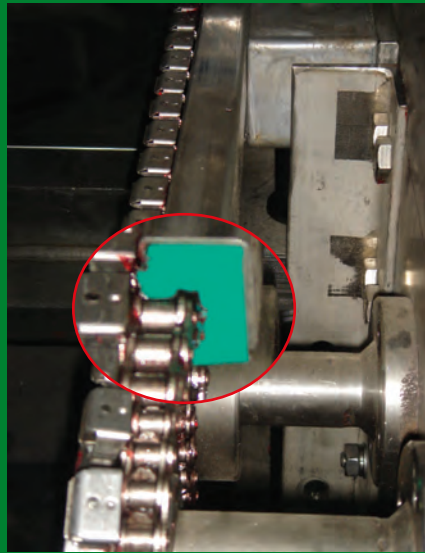
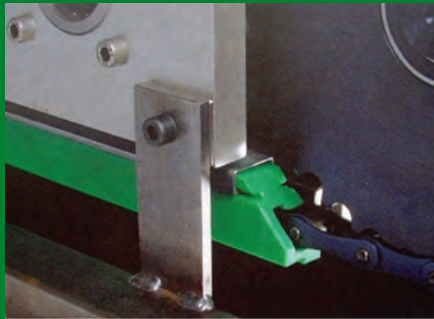
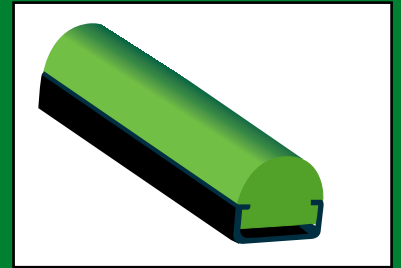
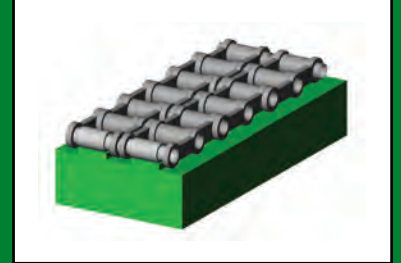
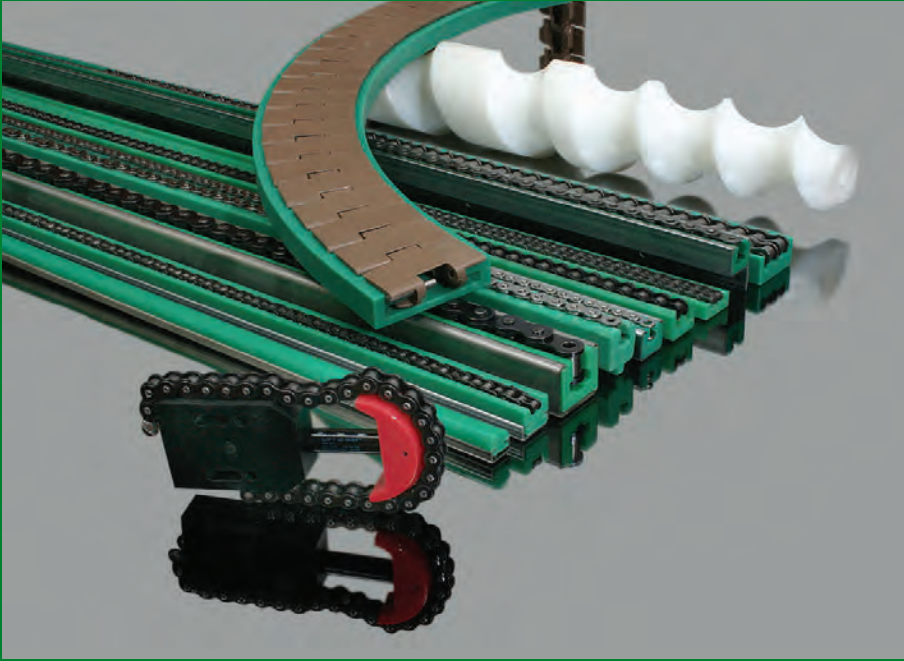

**Gültekinoğlu Salih ÖZBİDECİLER**

Kurucu-Şeref Başkanı/Founder-President
Makine Mühendisi/İşletmeci Mechanical Eng./B.A
gultekinoglu@alhan-cagri.com

Pazarlama - Satış / Marketing - Sales Dep.

pazarlama@alhan-cagri.com
satis@alhan-cagri.com
asya@alhan-cagri.com
marmara@alhan-cagri.com
trakya@alhan-cagri.com

İhracat-İthalat/Export-Import

info@alhan-cagri.com
export@alhan-cagri.com
marketing@alhan-cagri.com
import@alhan-cagri.com

Üretim / Production

uretim@alhan-cagri.com

Satınalma / Purchasing

satinalma@alhan-cagri.com

Muhasebe / Accounting

muhasebe@alhan-cagri.com

Finans / Finance

finans@alhan-cagri.com

Arge / R&D

arge@alhan-cagri.com

Davutpaşa Cad./St. Nu:14/1 34010 Topkapı-İSTANBUL-TÜRKİYE

 +90.212.444 00 42-544 50 55 Belgegeçer (Fax):+90.212.567 14 16-501 54 08

 www.alhan-cagri.com e-posta/e-mail:info@alhan-cagri.com

İbrahim Ethem İlaç Fabrikası Yanı Ülker Fab. 150 mt. Gerisi MB İş Merkezi
From Airport:By light rail it will take appr. 15 min. to be in Davutpaşa station.
By Car or Taxi:Just near the Ülker factory in Davutpaşa area. MB Center

SEMBOLLER/SYMBOLS



Birlikte kullanılan bantın stok kodunu gösterir.
Chain's stock code



Birlikte kullanılan dişlinin yada kasnağın bulunduğu sayfayı gösterir.
Sprocket's or idler's pages

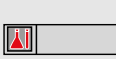

Standart parça
Standard parts



Kimyasal direnç tablosunun bulunduğu sayfayı gösterir.
Chemical resistance table's pages



Malzeme/Material



Dişlinin yada kasnağı iki parçalı olduğunu gösterir.
Two unit for sprocket's or idler's



Kolideki azami parça adet sayısı
Recommended packaging



Dikkat
Warning



Antistatik
Antistatic



Kauçuklu bant
Chains with rubber



Kauçuk Bant/Rubber Chains



Yapışmaz/Non-Adhesive



Belgegeçer/Fax



Ağırlık/Load



Asit/Acıt



Alüminyum/Aluminium



Çelik/Steel



Yeni Ürünler/New Products



3 Boyutlu Çizim için / For 3D Model
www.alhan-cagri.com

SEMBOLLER/SYMBOLS

ABS Akrilonitril Butain Sitrin
Acrilonitrile Butotiene Styrene



Polietilen / Polyethylene



Polipropilen / Polypropylene



Poliasetal / Polyacetal



Polivinilklorür/Poly Vinil Clorur



Polibütlen Tereflat/Polybutylene Terephthalate



Polyemid/Polyamide



Paslanmaz Çelik/Stainless Steel



Çinko Kaplama/Zinc



Zamak Metal Döküm/Die Cast Zamak Lever Body



Pirinç / Brass



Ağır Tip/Heavy Type



Hafif Tip/Easy Type

L: Bant genişliği/Belts width

P: Hatve/Pitch

Ri: Tırmanma radyusu/Back bend radius

RM: En az dönüş radyusu/Min. curve radius

Rd: Çalışma yönü/Running direction

A: Avara/Idler

T: Tahrik/Drive

Kg/m: Metre başına düşen kilogram/Kilograms per meter

mm: Milimetre/Millimeter

PIN: Pim/Pin

DF: Göbek mil çapı/Shaft diameter

DE: Diş üstü çapı/Outside diameter

DP: Kavrama çapı/Primitive diameter

UYARI WARNING	AÇIKLAMALAR KNOWLEDGES
1	Yüklemeye bağlı olarak (AV) pabuç yükseklikleri 1-1.5 mm artmaktadır. (AV) Feets length increases 1-1.5 mm as a result of loadind.
2	Stok kodlarına PP ekleyerek polipropilen tabanlı pabuç isteyebilirsiniz. Despite of (PP) adding to Stock Code you can give your request for polypropylene feets. 501 400 880 → PA 501 400 880 PP → PP

Katalogtaki ürünleri tasarımları değişikliğe uğrayabilir ve değişiklikten doğabilecek sorunlardan firmamız sorumlu değildir.
In catalogue, our product's design will be changed and as a result of this we have no response.



PROFİLLER/PROFILES **B3-B18**



ZİNCİR KIZAKLARI/ROLLER CHAIN GUIDES **B19-B32**



DOĞRUSAL YATAKLAR/STRAIGHT TRACK **B33-40**

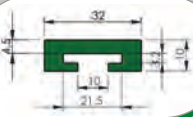

PROFİLLER/PROFILES **B41-B61**

UYGULAMALAR/APPLICATIONS **B62**

KİMYASAL DİRENÇ/CHEMICAL RESISTANT **B63-B64**

ALPOLLEN® 1000 - ALPOLLEN® 500 - ALPOLLEN® 2000

Malzeme katsayısının düşük olması, kimyasal etkilere karşı dayanıklı olması, gıda ile etkilere dayanıklı olması, yumuşak malzeme olması ile özellikle tekstil, gıda ve içecek sanayilerinde kullanılmasını sağlamıştır. Moleküler ağırlığının artırılması ile teknik özellikler artmaktadır. Artan moleküler ağırlıkta şu özellikler artmaktadır. İç dayanım, yüksek sıcaklıklarda gerilme mukavemeti, güç sarfiyatı, çatlama ve aşınma gerilmesine karşı dayanım, mükemmel düşük sıcaklık performansı.

Kimliği:

Yoğunluk	: 0,96 gr / cm 3	Bozunum faktörü	: 0,005 (10 ^{3.2} HZ)
Erime noktası	: 130 °C	Eğilme mukavemeti	: 300 kg / cm ²
Sertlik	: m 53 Rockwell	Yüzeysel dayanım	: orta
Azami Çalışma Sıcaklığı	: 80 °C	Gerilme mukavemeti	: 260 kg / cm ²
Kopma uzaması	: %800	Elektrik yalıtkanlığı	: 2,4 (10 ^{3.2} HZ)
Isı ile bozunum	: 55 - 80 °C	İşlenebilirlik	: iyi
Su absorpsyonu (emme):	%0,1	Işık yalıtkanlığı	: zayıf
Isısal genişleme kats.	: 2.10 ⁻⁴	Besinlerle temas	: çok iyi
Sürtünme katsayısı	: 0,20	Asitlere dayanım	: iyi
Basma mukavemeti	: 300 kg / cm ²	Bazlara dayanım	: iyi

Yarımamül sevkiyatları :
Yuvarlak malzemeleri : Ø 10 mm'den Ø 300 mm'kadar
Plaka malzemeleri : 5 mm'den 100 mm'kadar

Ayrıca isteğe göre düzenlenir.

Alpolen® 1000 : UHMW PE : Moleküler ağırlığı 3,5.10⁶ ile 10,5.10⁶ gr/mol çok yüksek moleküler ağırlık
Alpolen® 500 : HMW PE : Moleküler ağırlığı 500.000 gr/mol yüksek moleküler ağırlık
Alpolen® 2000 : UHMW PE : Moleküler ağırlığı 3,5.10⁶ gr/mol'den büyük çok yüksek moleküler ağırlık
Kullanım sahaları :

Kömür depolarında konveyör sistemlerinde, oluklarda, zincir konveyör klavuzlarında, kovalı elevatörlerde, elektrik güç istasyonlarında, çimento, kireç, alçı, besin gıda endüstrilerinde, kesme ve doğrama plakaları, doğrama blokları, konveyör vidaları, kayma elemanları, yassı klavuzlar, profiller, makaralar, yıldız ve vida konveyörlerinde, elevatör sistemleri için, ayakkabı hattı klavuzu, kaymalı yataklarda vites dişlilerinde, motor indirme levhalarında, stop valfleri, kapama klapelerinde, pompalar fitreler ve diğerleri.

ALPOLLEN® 500

Molekül ağırlığı + / -500.000 olan Alpolen®'dir. Alpolen® 500 yüksek molekül ağırlığından dolayı daha sert bir polietilendir dolayısıyla kullanım alanları için çok uygundur. Sürtünme katsayısı düşük, makinede işlenebilirliği çok mükemmeldir.

Zayıf nokta: Diğer mühendislik plastikleri ile karşılaştırıldığında düşük termal ve mekanik özelliklere, gerilme kuvvetine, esnek ve sıkıştırıcı kuvvete sahiptir. Yüksek molekül ağırlıklı Alpolen® 1000 ve 500 karşılaştırıldığında, 1000 malzemenin daha sert ve sürekli şok anında mukavemetinin daha yüksek olduğu anlaşılmıştır.

Gri : Şok mukavemet
Kırmızı : Gerilim kuvveti
Yüksek molekül ağırlığı, yüksek şok mukavemetini gösteren tabloya göre düşüşler gözlenir.

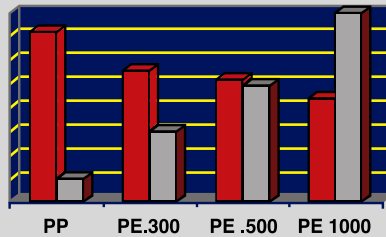

Alpolen® 1000 ve 500 malzemeye ait daha geniş teknik bilgi ve teknik uygulamalar için lütfen

www.alhan-cagri.com
sitesini ziyaret ediniz.

ALPOLLEN® 2000

Alpolen® molekül ağırlığı > 3,5 milyon gr/mol çok yüksek moleküler ağırlığa sahiptir (UHMW Ultra High Molecular Weight) alev geciktirici, Holojen geçirgenliği, antistatik özellik, UV ışığı altında dışarda kullanım, Ağır tip uygulamalar için yüksek sürtünme dayanımı, Antibakteriyel gibi nitelikler (FDA ile BfR) kazandırılarak geliştirilmiş UHMW (çok yüksek moleküler ağırlıklı) Polietilen malzemedir.

ALPOLLEN® 1000

Alpolen® molekül ağırlığı 3,5 milyon gr/mol ile 10,5 milyon gr/mol arası olarak bilinen mükemmel sıkıştırma gücüne sahip bir malzemedir. Düşük moleküler ağırlıklı Alpolen® lere nazaran Alpolen® 1000, daha az sert ve daha yüksek şok mukavemetlerine sahiptir.

Sürekli devam eden şokdurumları içeren kullanım alanlarına uygundur.

Özellikleri : Yüksek kimyasal mukavemet, düşük aşınma, sürtünme katsayısı düşüktür. Natural renkte, kolay işlenebilir.

Zayıf nokta : Diğer mühendislik plastikleri ile karşılaştırıldığında düşük temas ve mekanik özelliklere, gerilme kuvvetine, esnek ve sıkıştırma kuvvetine sahiptir.

Kullanım alanları: Sahip olduğu özellikler açısından gıda ile temas edebilir. Özellikle geniş kullanım alanı vardır, gıda makineleriyle kullanılır. Asitlere ve alkalilere karşı yüksek mukavemet gösterdiği için kimya endüstrisinde tercih edilir. Elektrik endüstrisinde yüksek dielektrik özelliklerinden ve hür türlü havaya dayanıklı olmasından dolayı kullanılır. Düşük sürtünme katsayılı olmasından dolayı, mil yatağı, mekanik parçalar yapımında ve -su içinde dahi- operasyon olduğunda tercih edilir.



B ALPOLLEN® 1000 - ALPOLLEN® 500 - ALPOLLEN® 2000

Polyethylene with a molecular weight of +/- 3,5.10⁶ with 10,5.10⁶ PE UMW 1000 is more rigid than the high molecular weight polyethylene (PE 500) and it is therefore more suitable for mechanical applications. The friction coefficient is low and machinability is excellent.

FEATURES

Chemical: high chemical resistance typical of the polyolefins
 Shock resistance, good even at low temperature
 High abrasion resistance
 Low friction coefficient
 Low specific gravity
 Easy machinability
 colour: natural

Identity:

Density	: 0,96 g/cm ³	Prolonged Factor	: 0,005 (10 ³ .HZ)
Melt Temperature	: 130 °C	Bending Strength	: 300 kg / cm ²
Hardness	: m 53 Rockwell	Surface Resistance	: Normal
Working Temperature	: 80°C	Tension Strength	: 260 kg / cm ²
Breaking Prolonged	: %800	Dielectric Strength	: 2,4 (10 ³ .HZ)
Thermal Prolonged	: 55 - 80°C	Behaviour in Manufacturing	: good
Water Absorption	: %0,1	Light Resistance	: weak
Thermal Expanding	: 2.10 ⁻⁴	Food Available	: well
Friction Coefficient	: 0,20	Acid Resistance	: good
Pressing Strength	: 300 kg/cm ²	Base Resistance	: good

WEAK POINT

Compared to the engineering plastics it has lower thermal and mechanical properties : tensile stress, flexural and compressive strength, etc. Compared to high molecular weight PE, it is more rigid and its resistance to continuous shock is therefore lower

APPLICATION

Food contact: physiologically inert, it is approved for food contact by the most important standards. Thanks to this feature, it is widely used for components in food machinery, pumps for liquid food etc.

Chemical: thanks to the high resistance to acids and alkali it is used to produce components ifor the chemical industry.

Electrical: very good dielectric properties, weatherproof.

Mechanical: the low friction coefficient and its non hygroscopicity make it suitable for use as a bearing or for mechanical parts with low loads, even when operating in water.

The graph shows that the higher the molecular weight is, the higher the shock resistance, but that tensile stress decreases.

Red : tensile stress

Grey: shock resistance

ALPOLLEN® 2000

Modified for the specific applications of our customers.

- With antistatic finish and additional lubricant for the conveyor industry.
- With added antioxidants, for example, which can be used at high temperatures.
- With additional flame retardant properties for use in rail vehicle, machinery and mining construction.
- With enhanced antibacterial effects.

Ultra-high molecular weight low pressure polyethylene with a molecular weight 3.500.000 g/mol plus additives for the improvement of specific metarial properties.

ALPOLLEN® 500

Polyethylene with a molecular weight of +/- 500.000 with semi-finished products made of ALPOLLEN® 500 we offer you a material which, thanks to its characteristics, quality and price, is the first choice for many applications. Particularly in the food industry and in sports centre construction, ALPOLLEN® 500 does an excellent job with its impact strength and insulating properties — and that at competitive costs.

ALPOLLEN® 500 complies in full with all applicable regulations for contact with food. In addition to its use as a cutting board, as lining or as impact protection, it is also useful in other applications, for example in machine construction.

FEATURES

Shock resistance, good even at low temperatures
 High chemical resistance typical of the polyolefins
 High abrasion resistance
 Low friction coefficient
 Low specific gravity
 Easy machinability
 colour: natural

WEAK POINT

Compared to the engineering plastics it has lower thermal and mechanical properties: tensile stress, flexural and compressive strength, etc. Compared to low molecular weight PE, it is less rigid.

APPLICATION

Food contact : physiologically inert, it is approved for food contact by the most important standards. Thanks to this feature, it is widely used for components in food machinery, pumps for liquid food etc.

Chemical: thanks to the high resistance to acids and alkali it is used for components in the chemical industry

Electrical : very good dielectric properties, weatherproof

Mechanical: the low friction coefficient and its non hygroscopicity make it suitable for use as a bearing or mechanical parts with low loads, even when operating in water.

The graph shows that the higher the molecular weight is, the higher the shock resistance, but that tensile stress decreases.

Red : tensile stress

Grey: shock resistance

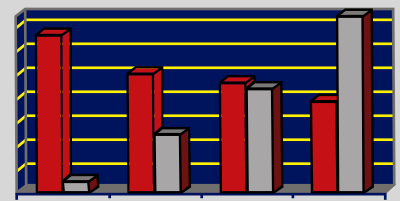

PP PE.300 PE.500 PE 1000
 Alpolen® 1000 and 500 for more technical details and application please you can visit

www.alhan-cagri.com



ÇAĞRI[®]
ENDÜSTRİ A.Ş.

ALHAN[®]

PROFİLLER PROFILES

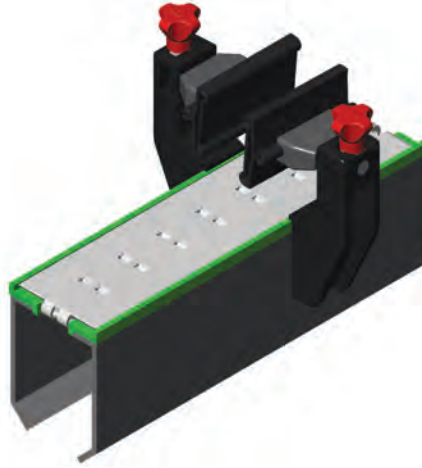

Üretimden Satış
от производства к продаже
From Production to Sales



B Z PROFİL ALPOLEN® 1000 / GUIDES FOR BOTTLING AND PACKAGING

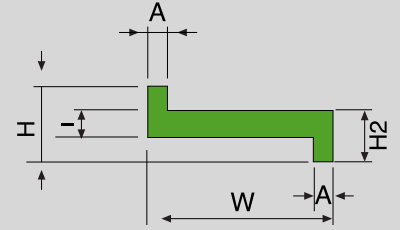
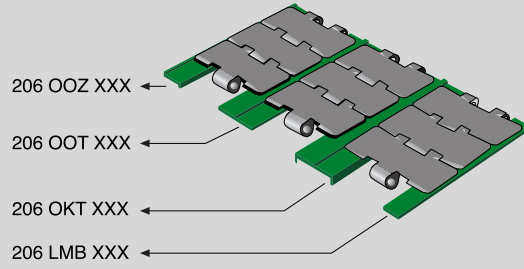
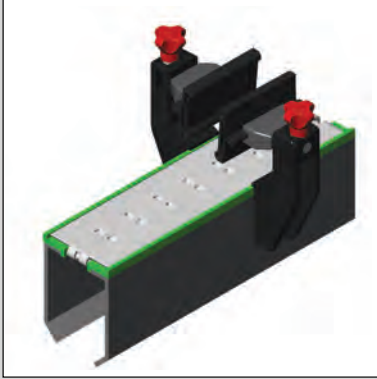

Profil Bölümü/Profiles: "Z"

L: Standart Uzunluk (metre)/Standart Length (meter)

M	Açıklama Characteristic	W	A	H	I	H2	L	Kg/m	Stok Kod Stock Code
M	Alpolen® 1000 - Yeşil / Green	20	2	5,5	3	5,5	50	0,7	206 OOO 003
	Alpolen® 1000 - Siyah / Black								206 OOO 002
M	Alpolen® 1000 - Yeşil / Green	23	3	7	4	7	50	12	206 OOO 005
	Alpolen® 1000 - Siyah / Black								206 OOO 004

DÜZ LAMA PROFİL ALPOLEN® 1000 / FLAT GUIDES

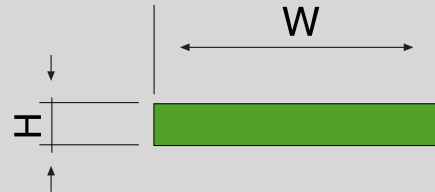
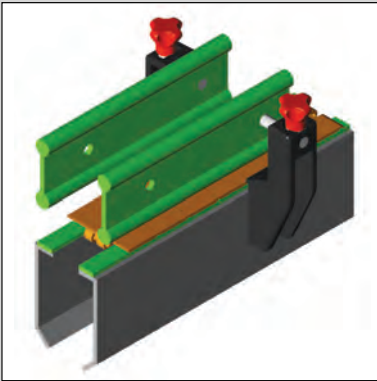

Profil Bölümü/Profiles: "LAMA"

L: Standart Uzunluk (metre)/Standart Length (meter)

M	L	H	W							
			15	20	25	30	35	40	45	50
M	50	3	206 LMY 315	206 LMY 320	206 LMY 325	206 LMY 330	206 LMY 335	206 LMY 340	206 LMY 345	206 LMY 350
			206 LMS 315	206 LMS 320	206 LMS 325	206 LMS 330	206 LMS 335	206 LMS 340	206 LMS 345	206 LMS 350
M	50	5	206 LMY 515	206 LMY 520	206 LMY 525	206 LMY 530	206 LMY 535	206 LMY 540	206 LMY 545	206 LMY 550
			206 LMS 515	206 LMS 520	206 LMS 525	206 LMS 530	206 LMS 535	206 LMS 540	206 LMS 545	206 LMS 550
M	50	2	206 LMB 215	206 LMB 220	206 LMB 225	206 LMB 230	206 LMB 235	206 LMB 240	206 LMB 245	206 LMB 250
			206 LMB 415	206 LMB 420	206 LMB 425	206 LMB 430	206 LMB 435	206 LMB 440	206 LMB 445	206 LMB 450

Çağrı End. A.Ş. gerekli gördüğü takdirde, teknik gelişmeler neticesinde kataloğtaki çizim ve değerler üzerinde haber vermeksizin değişiklik yapma hakkına sahiptir.

Çağrı Endüstri is reserved the right to update the technical specifications and values in this catalogue at any time without prior notice.

*Özel üretim yapılır. / On request special production is available.



GEÇMELİ Z PROFİL ALPOLEN® 1000 / GUIDES FOR BOTTLING AND PACKAGING

B

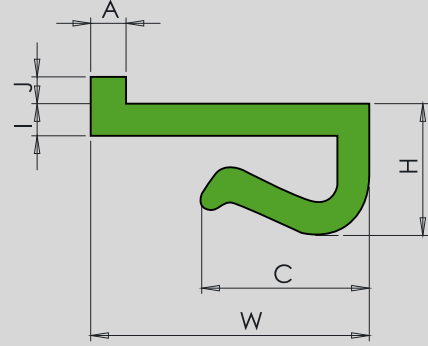
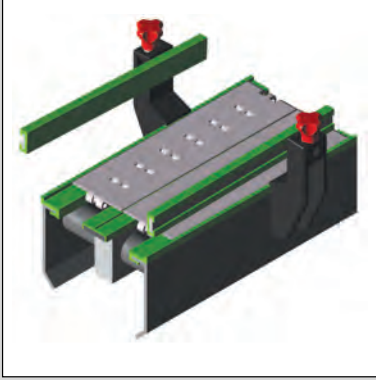

Profil Bölümü/Profiles: "Z"

L: Standart Uzunluk (metre)/Standart Length (meter)

	Açıklama Characteristic	W	A	H	I	J	C	L	Kg/m	Stok Kod Stock Code
Alpolen® 1000 - Yeşil / Green	P/P 21 m.	21	2,5	9	3	2,5	13	50	0,12	206 OGZ 001
Alpolen® 1000 - Siyah / Black										206 OGZ 003
Alpolen® 1000 - Yeşil / Green	PP/25 m.	25	2,5	9	3	2,5	13	50	0,17	206 OGZ 002
Alpolen® 1000 - Siyah / Black										206 OGZ 004

GEÇMELİ LAMA PROFİL ALPOLEN® 1000 / GUIDES FOR BOTTLING AND PACKAGING

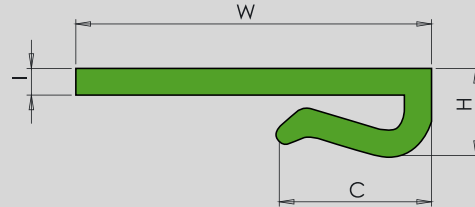
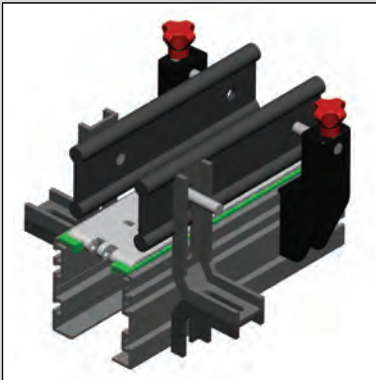

Kullanılacak Profil 1,5-3 mm kalınlığındadır.
Wearstrip to be used with plate width of 1,5 to 3mm.

Profil Bölümü/Profiles: "LAMA"

L: Standart Uzunluk (metre)/Standart Length (meter)

	Açıklama Characteristic	W	H	I	C	L	Kg/m	Stok Kod Stock Code
Alpolen® 1000 - Yeşil / Green	P21	P21	10,6	3	13	50	0,11	206 GLA 100
Alpolen® 1000 - Siyah / Black								206 GLA 101
Alpolen® 1000 - Yeşil / Green								206 GLA 102
Alpolen® 1000 - Siyah / Black	P25	P25	10,5	3	20	50	0,12	206 GLA 103
Alpolen® 1000 - Yeşil / Green								206 GLA 104
Alpolen® 1000 - Siyah / Black	P40	P40	11,5	3	13	50	0,18	206 GLA 105
Alpolen® 1000 - Yeşil / Green								206 GLA 106
Alpolen® 1000 - Siyah / Black								206 GLA 107
Alpolen® 1000 - Yeşil / Green	P40	P40	10,3	3	20	50	0,16	206 GLA 108
Alpolen® 1000 - Siyah / Black								206 GLA 109

Çağrı End. A.Ş. gerekli gördüğü takdirde, teknik gelişmeler neticesinde kataloğtaki çizim ve değerler üzerinde haber vermeksizin değişiklik yapma hakkına sahiptir.

Çağrı Endüstri is reserved the right to update the technical specifications and values in this catalogue at any time without prior notice.

*Özel üretim yapılır. / On request special production is available.



B PROFİL ALPOLEN® 1000 / GUIDES FOR BOTTLING AND PACKAGING

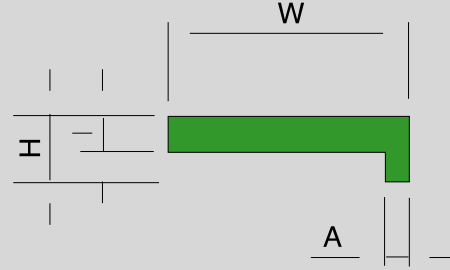
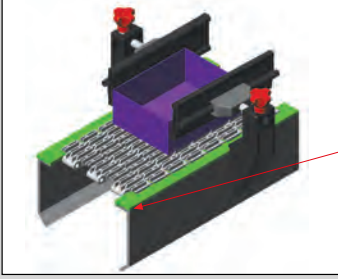

Profil Bölümü/Profiles: "L"

L: Standart Uzunluk (metre)/Standart Length (meter)

M	Açıklama Characteristic	W	A	H	I	L	Kg/m	Stok Kod
								Stock Code
L	Alpolen® 1000 - Yeşil / Green Alpolen® 1000 - Siyah / Black Alpolen® 1000 - Yeşil / Green	20	2	5,5	3	60	0,06	206 OOL 001
				6			0,16	206 OOL 002
		35	5	12	0,15		206 OOL 013	
				10	0,14		206 OOL 014	
		40	10	15	0,16		206 OOL 015	

L/600 PROFİL ALPOLEN® 1000 / GUIDES FOR BOTTLING AND PACKAGING

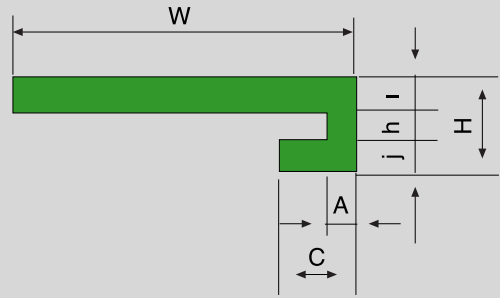
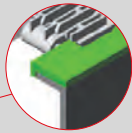
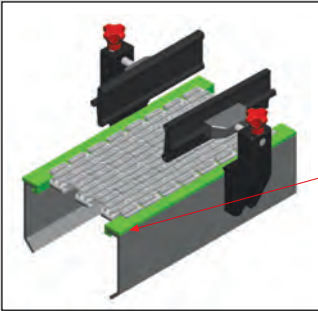

Profil Bölümü/Profiles: "L"

L: Standart Uzunluk (metre)/Standart Length (meter)

M	W	A	H	I	L	C	H	J	Kg/m	Stok Kod	
										Stock Code	
L	Alpolen® 1000 - Yeşil / Green Alpolen® 1000 - Siyah / Black Alpolen® 1000 - Yeşil / Green Alpolen® 1000 - Siyah / Black Alpolen® 1000 - Yeşil / Green Alpolen® 1000 - Siyah / Black Alpolen® 1000 - Yeşil / Green Alpolen® 1000 - Siyah / Black	40	10	8	3	2	25	3	2	0,19	206 OTL 001
				3,6			8	2,8	3,6	0,14	206 OTL 002
		35	3	10	4		11	3	3	0,11	206 OTL 003
				14	3		10	3	0,11	206 OTL 004	
		23	3	10	4		11	3	3	0,11	206 OTL 005
				14	3		10	3	0,11	206 OTL 006	
		45	4	14	3		10	8,5	2,5	0,19	206 OTL 007
				14	3		10	8,5	2,5	0,19	206 OTL 008

Çağrı End. A.Ş. gerekli gördüğü takdirde, teknik gelişmeler neticesinde kataloğtaki çizim ve değerler üzerinde haber vermeksizin değişiklik yapma hakkına sahiptir.

Çağrı Endüstri is reserved the right to update the technical specifications and values in this catalogue at any time without prior notice.

*Özel üretim yapılır. / On request special production is available.



ALPOLEN® 1000 SÜRTÜNME PROFİLLERİ / GUIDES FOR BOTTLING AND PACKAGING

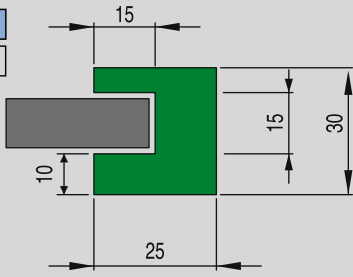
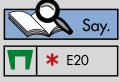

207 DON 001

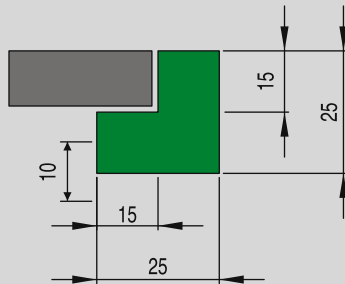

207 DON 002

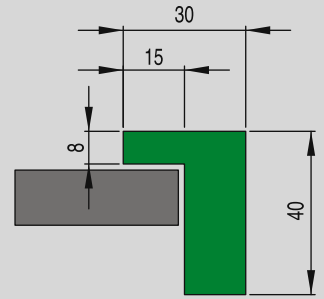

207 DON 003

Profil Bölümü/Profiles: "T" L: Standart Uzunluk (metre)/Standart Length (meter)

		M	L	Kg/m	Stok Kod Stock Code
Alpolen® 1000 - Yeşil / Green		2		0,75	207 DON 001
Alpolen® 1000 - Siyah / Black				0,64	207 DON 002
Alpolen® 1000 - Siyah / Black				0,68	207 DON 003

T PROFİL ALPOLEN® 1000 / GUIDES FOR BOTTLING AND PACKAGING

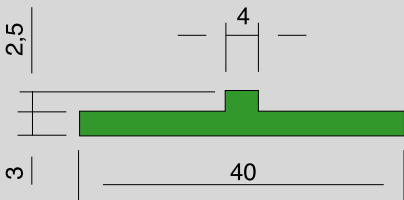

Profil Bölümü/Profiles: "T" L: Standart Uzunluk (metre)/Standart Length (meter)

		M	L	Kg/m	Stok Kod Stock Code
Alpolen® 1000 - Yeşil / Green		50		0,11	206 OTL 003
Alpolen® 1000 - Siyah / Black					206 OTL 004

TCA PROFİL ALPOLEN® 1000 / GUIDES FOR BOTTLING AND PACKAGING

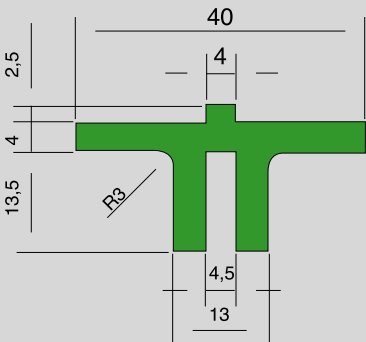

Profil Bölümü/Profiles: "T" L: Standart Uzunluk (metre)/Standart Length (meter)

		M	L	Kg/m	Stok Kod Stock Code
Alpolen® 1000 - Yeşil / Green		2		0,30	206 UOT 001
Alpolen® 1000 - Siyah / Black					206 UOT 002

TCAL PROFİL ALPOLEN® 1000 / GUIDES FOR BOTTLING AND PACKAGING

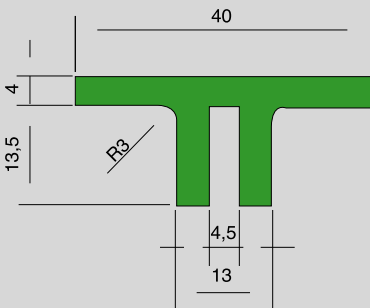

Profil Bölümü/Profiles: "T" L: Standart Uzunluk (metre)/Standart Length (meter)

		M	L	Kg/m	Stok Kod Stock Code
Alpolen® 1000 - Yeşil / Green		2		0,29	206 DOT 001
Alpolen® 1000 - Siyah / Black					206 DOT 002

Çağrı End. A.Ş. gerekli gördüğü takdirde, teknik gelişmeler neticesinde kataloğtaki çizim ve değerler üzerinde haber vermeksizin değişiklik yapma hakkına sahiptir.

Çağrı Endüstri is reserved the right to update the technical specifications and values in this catalogue at any time without prior notice.

*Özel üretim yapılır. / On request special production is available.



B ALPOLEN® 1000 ÇELİK PROFİLLİ HCP KIZAKLARI/GUIDES FOR BOTTLING AND PACKAGING

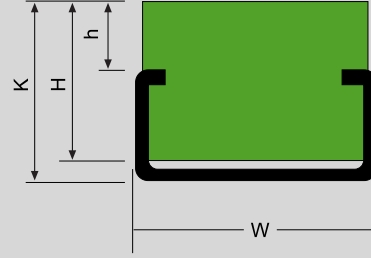
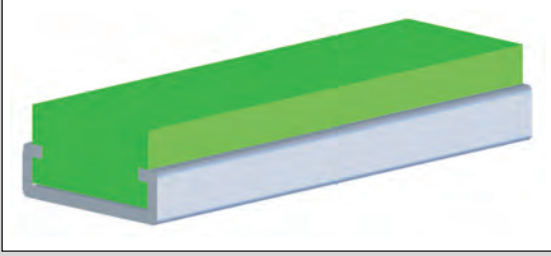

Profil Bölümü/Profiles: "L"

L: Standart Uzunluk (metre)/Standart Length (meter)

M	Kılavuz Guide	W	K	H	h	L	Kg/m	Stok Kod / Stock Code	
Alpolen® 1000 Yeşil / Green	C 2405 ZN	20	6	5	0,8	2	0,350	207 HCC 006	
	C 2405 SS		207 HCP 006						
	C 2405 ZN	20	11	10	5,8		0,450	207 HCC 011	
	C 2405 SS		207 HCP 011						
	C 2010 ZN	20	14	10	4		0,790	207 HCC 014	
	C 2010 SS		207 HCP 014						
	C 2010 ZN	20	17	15	7		0,880	207 HCC 017	
	C 2010 SS		207 HCP 017						
	C 2010 ZN	20	22	20	12		0,940	207 HCC 022	
	C 2010 SS		207 HCP 022						
	C 2812 ZN	28	15	10	3		1,180	207 HCC 015	
	C 2812 SS		207 HCP 015						
	C 2812 ZN	28	18	15	6		1,320	207 HCC 018	
	C 2812 SS		207 HCP 018						
	C 2812 ZN	28	24	20	12		1,488	207 HCC 024	
	C 2812 SS		207 HCP 024						
	C 3818 ZN	38	22	12	4		2,200	207 HCC 122	
	C 3818 SS		207 HCP 122						
	C 3818 ZN	38	24	15	6		2,460	207 HCC 124	
	C 3818 SS		207 HCP 124						
C 3818 ZN	38	30	20	12	2,690	207 HCC 030			
C 3818 SS		207 HCP 030							
C 6020 ZN	60	30	20	10	3,260	207 HCC 130			
C 6020 SS		207 HCP 130							

ALPOLEN® 1000 "C" SÜRTÜNME PROFİLLERİ/ "C" GUIDES FOR BOTTLING AND PACKAGING

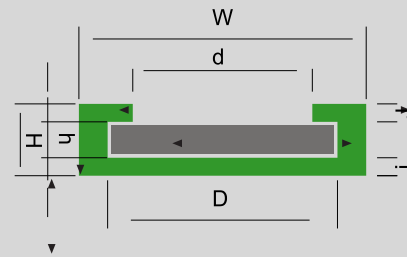
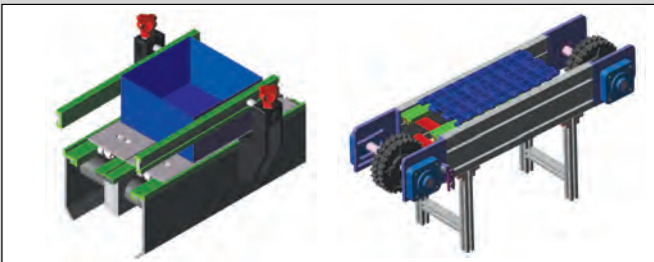

Profil Bölümü/Profiles: "C"

L: Standart Uzunluk (metre)/Standart Length (meter)

M	W	H	i	h	J	D	d	L	Kg/m	Stok Kod / Stock Code	
Alpolen® 1000 Yeşil / Green	30	12	3,5	5,2	3,3	20,5	12	2	0,17	207 CC3 012	
	40	10	3,5	3,5	3	30,5	23		0,19	207 CC4 010	
	50	10,5	3	4,5	3		28,5	50	0,24	207 CC5 015	
	50	14	3	8,3	2,7	41	30		0,26	207 CC5 014	
	50	16	3	10,3	2,7		30	2	0,27	207 CC5 016	
	60	12	3	6,5	2,5	51	35	50	0,28	207 CC6 012	

Çağrı End. A.Ş. gerekli gördüğü takdirde, teknik gelişmeler neticesinde kataloğtaki çizim ve değerler üzerinde haber vermeksizin değişiklik yapma hakkına sahiptir.

Çağrı Endüstri is reserved the right to update the technical specifications and values in this catalogue at any time without prior notice.

*Özel üretim yapılır. / On request special production is available.



KULAKLI T PROFİL PROFİL ALPOLEN® 1000 / PROFILES OF BEVEL CHANNEL

B

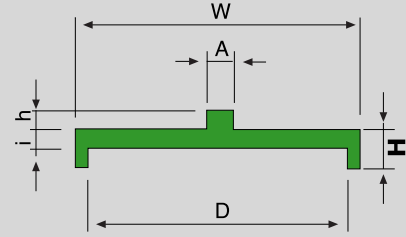
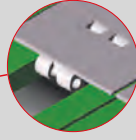
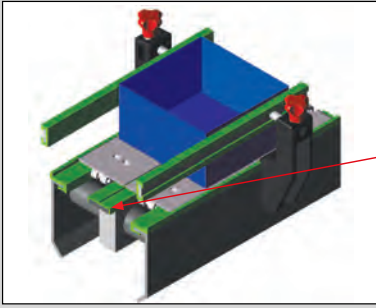

Profil Bölümü/Profiles: "T"

L: Standart Uzunluk (metre)/Standart Length (meter)

	Açıklama Characteristic	W	D	H	i	h	A	L	Kg/m	Stok Kod Stock Code
	Alpolen® 1000 - Yeşil / Green	40	36	9	3	3	4	50	0,13	206 OKT 401
	Alpolen® 1000 - Siyah / Black									206 OKT 402
	Alpolen® 1000 - Yeşil / Green	43	31	15	4	3	3		0,21	206 OKT 431
	Alpolen® 1000 - Siyah / Black									206 OKT 432
	Alpolen® 1000 - Yeşil / Green	44	32	8	3	2,5	4		0,16	206 OKT 441
	Alpolen® 1000 - Siyah / Black									206 OKT 442
	Alpolen® 1000 - Yeşil / Green	46	41	11,5	3	4	4		0,17	206 OKT 461
	Alpolen® 1000 - Siyah / Black									206 OKT 462

ÇİFT KULAKLI C PROFİL ALPOLEN® 1000 / GUIDES FOR BOTTLING AND PACKAGING

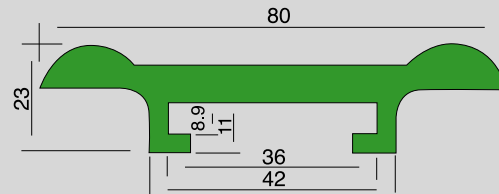
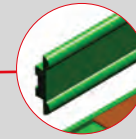
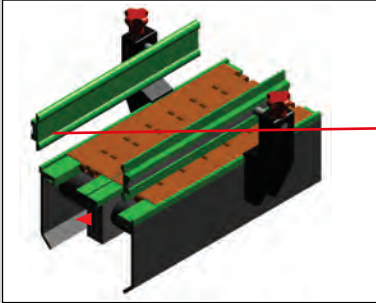

Profil Bölümü/Profiles: "YD"

L: Standart Uzunluk (metre)/Standart Length (meter)

	L	Kg/m	Stok Kod Stock Code
	2	0,73	206 YD3 001
			206 YD3 002

ALPOLEN® 1000 "C" SÜRTÜNME PROFİLLERİ/ "C" GUIDES FOR BOTTLING AND PACKAGING

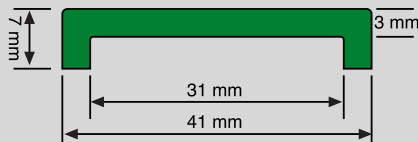

Profil Bölümü/Profiles: "YD"

L: Standart Uzunluk (metre)/Standart Length (meter)

	L	Kg/m	Stok Kod Stock Code
	2	0,170	206 YD2 001
			206 YD2 002

Çağrı End. A.Ş. gerekli gördüğü takdirde, teknik gelişmeler neticesinde kataloğtaki çizim ve değerler üzerinde haber vermeksizin değişiklik yapma hakkına sahiptir.

Çağrı Endüstri is reserved the right to update the technical specifications and values in this catalogue at any time without prior notice.

*Özel üretim yapılır. / On request special production is available.



B U/630 PROFİL ALPOLEN® 1000 / GUIDES FOR BOTTLING AND PACKAGING

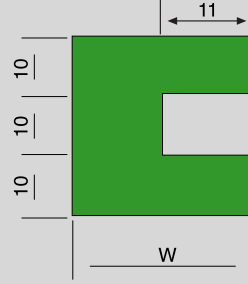
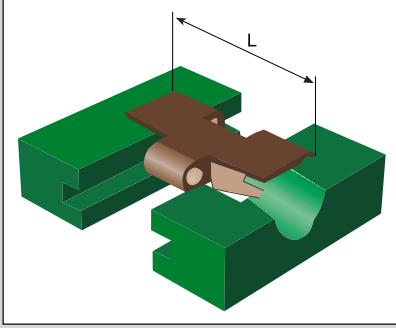

W = 30
L = 82,5

W = 40
L = 114,3

Profil Bölümü/Profiles: "T" L: Standart Uzunluk (metre)/Standart Length (meter)

	W	L	Kg/m	Stok Kod Stock Code
Alpolen® 1000 - Yeşil / Green	30	2	0,70	206 YU1 001
Alpolen® 1000 - Siyah / Black	40		0,98	206 YU1 002

U/640 PROFİL ALPOLEN® 1000 / GUIDES FOR BOTTLING AND PACKAGING

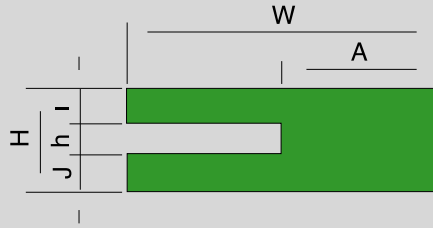

Profil Bölümü/Profiles: "U" L: Standart Uzunluk (metre)/Standart Length (meter)

	W	H	A	I	h	J	L	Kg/m	Stok Kod Stock Code
Alpolen® 1000 - Yeşil / Green	30	10	15	3,5	3	3,5	2	0,25	206 YU2 001
Alpolen® 1000 - Siyah / Black									206 YU2 002

U/650 PROFİL ALPOLEN® 1000 / GUIDES FOR BOTTLING AND PACKAGING

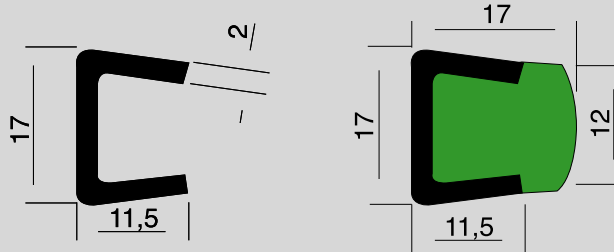
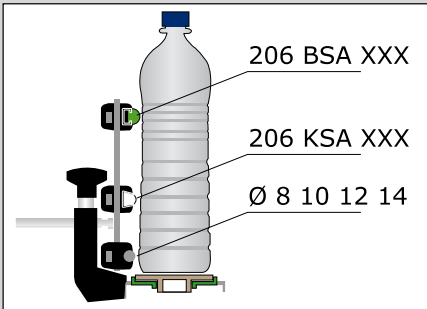

Profil Bölümü/Profiles: "Konik/Conical" L: Standart Uzunluk (metre)/Standart Length (meter)

	Kılavuz Guide	L	Kg/m	Stok Kod Stock Code
Alpolen® 1000 - Yeşil / Green	C 1711 SS	2	0,69	206 KSP 001
Alpolen® 1000 - Siyah / Black				206 KSP 002
Alpolen® 1000 - Yeşil / Green	C 1711 ZN			206 KSC 001
Alpolen® 1000 - Siyah / Black				206 KSC 002

Çağrı End. A.Ş. gerekli gördüğü takdirde, teknik gelişmeler neticesinde kataloğtaki çizim ve değerler üzerinde haber vermeksizin değişiklik yapma hakkına sahiptir.

Çağrı Endüstri is reserved the right to update the technical specifications and values in this catalogue at any time without prior notice.

*Özel üretim yapılır. / On request special production is available.



17'LİK BALIK SIRTI DÜZ PROFİL ALPOLEN® 1000 / PROFILES OF BEVEL CHANNEL

B

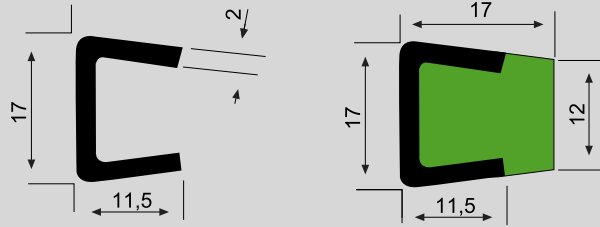
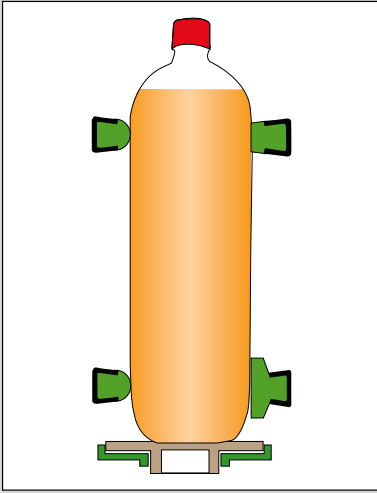

Profil Bölümü/Profiles: "Konik/Conical"

L: Standart Uzunluk (metre)/Standart Length (meter)

	Kılavuz Guide	L	Kg/m	Stok Kod Stock Code
Alpolen® 1000 - Yeşil / Green	C 1711 SS	2	0,69	206 KSD 101
Alpolen® 1000 - Siyah / Black	C 1711 SS			206 KSD 102
Alpolen® 1000 - Yeşil / Green	C 1711 ZN			206 KSD 201
Alpolen® 1000 - Siyah / Black	C 1711 ZN			206 KSD 202

OVAL BALIK SIRTI PROFİL ALPOLEN® 1000 / GUIDES FOR BOTTLING AND PACKAGING

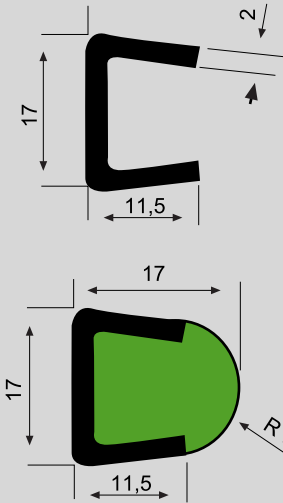

Profil Bölümü/Profiles: "Konik/Conical"

L: Standart Uzunluk (metre)/Standart Length (meter)

	Kılavuz Guide	L	Kg/m	Stok Kod Stock Code
Alpolen® 1000 - Yeşil / Green	C 1711 SS	2	0,67	206 KSA 101
Alpolen® 1000 - Siyah / Black	C 1711 SS			206 KSA 102
Alpolen® 1000 - Yeşil / Green	C 1711 ZN			206 KSA 201
Alpolen® 1000 - Siyah / Black	C 1711 ZN			206 KSA 202

YUVARLAK BALIK SIRTI PROFİL ALPOLEN® 1000 / GUIDES FOR BOTTLING AND PACKAGING

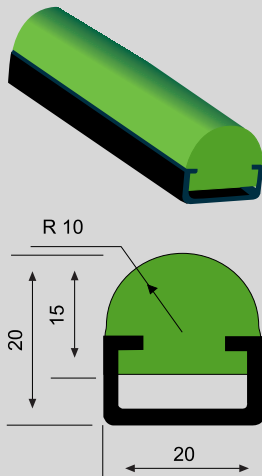

Profil Bölümü/Profiles: "Konik/Conical"

L: Standart Uzunluk (metre)/Standart Length (meter)

	Kılavuz Guide	L	Kg/m	Stok Kod Stock Code
Alpolen® 1000 - Yeşil / Green	C 2010 SS	2	0,70	206 BSA 101
Alpolen® 1000 - Siyah / Black	C 2010 SS			206 BSA 102
Alpolen® 1000 - Yeşil / Green	C 2010 ZN			206 BSA 201
Alpolen® 1000 - Siyah / Black	C 2010 ZN			206 BSA 202
Alpolen® 1000 - Yeşil / Green	C 2010 ZN		0,19	206 BSA 001
Alpolen® 1000 - Siyah / Black	C 2010 ZN			206 BSA 002

Çağrı End. A.Ş. gerekli gördüğü takdirde, teknik gelişmeler neticesinde kataloğtaki çizim ve değerler üzerinde haber vermeksizin değişiklik yapma hakkına sahiptir.

Çağrı Endüstri is reserved the right to update the technical specifications and values in this catalogue at any time without prior notice.

*Özel üretim yapılır. / On request special production is available.



B BS 100 PROFİL ALPOLEN® 1000/PROFILES OF BEVEL CHANNEL

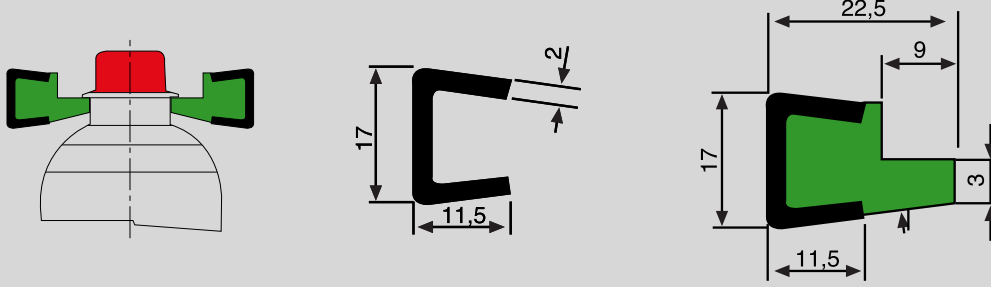

Profil Bölümü/Profiles: "Konik/Conical" L: Standart Uzunluk (metre)/Standart Length (meter)

	Kılavuz Guide	L	Kg/m	Stok Kod Stock Code
Alpolen® 1000 - Yeşil / Green	C 1711 SS	2	0,71	206 KL3 101
Alpolen® 1000 - Siyah / Black	C 1711 SS			206 KL3 102
Alpolen® 1000 - Yeşil / Green	C 1711 ZN			206 KL3 201
Alpolen® 1000 - Siyah / Black	C 1711 ZN			206 KL3 202

BS 800 PROFİL ALPOLEN® 1000/PROFILES OF BEVEL CHANNEL

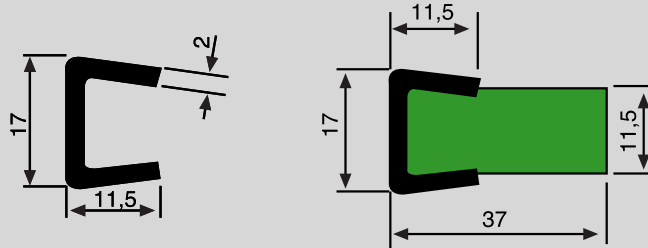

Profil Bölümü/Profiles: "Konik/Conical" L: Standart Uzunluk (metre)/Standart Length (meter)

	Kılavuz Guide	L	Kg/m	Stok Kod Stock Code
Alpolen® 1000 - Yeşil / Green	C 1711 SS	2	0,89	206 KL2 101
Alpolen® 1000 - Siyah / Black	C 1711 SS			206 KL2 102
Alpolen® 1000 - Yeşil / Green	C 1711 ZN			206 KL2 201
Alpolen® 1000 - Siyah / Black	C 1711 ZN			206 KL2 202

BS 900 PROFİL ALPOLEN® 1000/PROFILES OF BEVEL CHANNEL

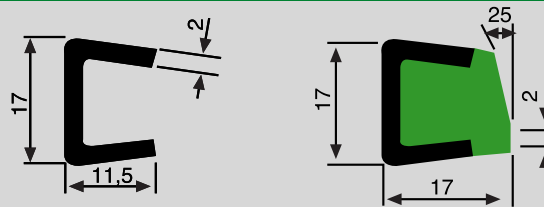
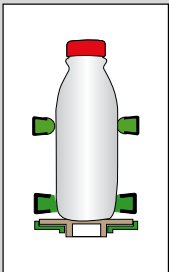

Profil Bölümü/Profiles: "Konik/Conical" L: Standart Uzunluk (metre)/Standart Length (meter)

	Kılavuz Guide	L	Kg/m	Stok Kod Stock Code
Alpolen® 1000 - Yeşil / Green	C 1711 SS	2	0,65	206 KL1 101
Alpolen® 1000 - Siyah / Black	C 1711 SS			206 KL1 102
Alpolen® 1000 - Yeşil / Green	C 1711 ZN			206 KL1 201
Alpolen® 1000 - Siyah / Black	C 1711 ZN			206 KL1 202

Çağrı End. A.Ş. gerekli gördüğü takdirde, teknik gelişmeler neticesinde kataloğtaki çizim ve değerler üzerinde haber vermeksizin değişiklik yapma hakkına sahiptir.

Çağrı Endüstri is reserved the right to update the technical specifications and values in this catalogue at any time without prior notice.

*Özel üretim yapılır. / On request special production is available.



BS 700 PROFİL ALPOLEN® 1000/PROFILES OF BEVEL CHANNEL

B

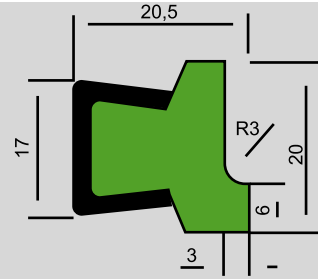
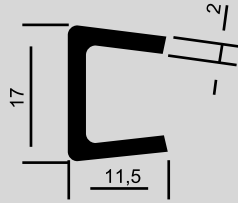
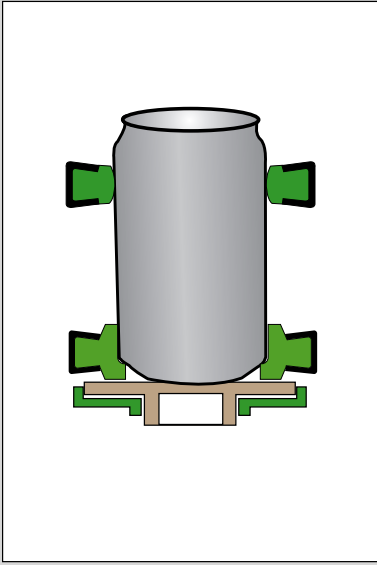

Profil Bölümü/Profiles: "Konik/Conical"

L: Standart Uzunluk (metre)/Standart Length (meter)

	Kılavuz Guide	L	Kg/m	Stok Kod Stock Code
Alpolen® 1000 - Yeşil / Green	C 1711 SS	2	0,71	206 KC3 101
Alpolen® 1000 - Siyah / Black				206 KC3 102
Alpolen® 1000 - Yeşil / Green	C 1711 ZN			206 KC3 201
Alpolen® 1000 - Siyah / Black				206 KC3 202

BS 200 PROFİL ALPOLEN® 1000/PROFILES OF BEVEL CHANNEL

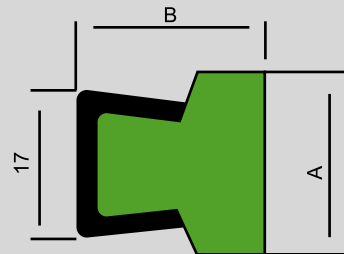
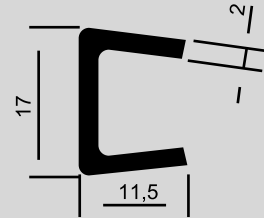
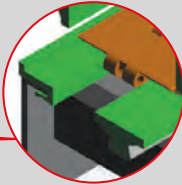
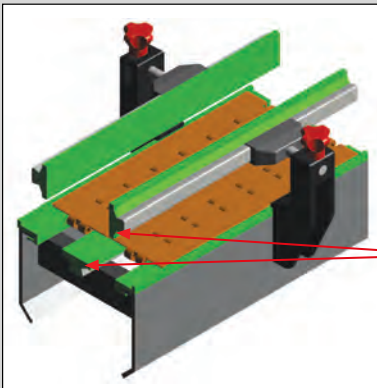

Profil Bölümü/Profiles: "Konik/Conical"

L: Standart Uzunluk (metre)/Standart Length (meter)

	Kılavuz Guide	L	A	B	Kg/m	Stok Kod Stock Code	
Alpolen® 1000 - Yeşil / Green	C 1711 SS	2	20	20,5	0,74	206 KC4 101	
Alpolen® 1000 - Siyah / Black						206 KC4 102	
Alpolen® 1000 - Yeşil / Green	C 1711 ZN					206 KC4 201	
Alpolen® 1000 - Siyah / Black						206 KC4 202	
Alpolen® 1000 - Yeşil / Green	C 1711 SS		0,78		20,5	0,78	206 KC5 101
Alpolen® 1000 - Siyah / Black							206 KC5 102
Alpolen® 1000 - Yeşil / Green	C 1711 ZN			206 KC5 201			
Alpolen® 1000 - Siyah / Black				206 KC5 202			
Alpolen® 1000 - Yeşil / Green	C 1711 SS			0,82	21	0,82	206 KC6 101
Alpolen® 1000 - Siyah / Black							206 KC6 102
Alpolen® 1000 - Yeşil / Green	C 1711 ZN		206 KC6 201				
Alpolen® 1000 - Siyah / Black			206 KC6 202				

Çağrı End. A.Ş. gerekli gördüğü takdirde, teknik gelişmeler neticesinde katalogtaki çizim ve değerler üzerinde haber vermeksizin değişiklik yapma hakkına sahiptir.

Çağrı Endüstri is reserved the right to update the technical specifications and values in this catalogue at any time without prior notice.

*Özel üretim yapılır. / On request special production is available.



B BS 100 PROFİL ALPOLEN® 1000/PROFILES OF BEVEL CHANNEL

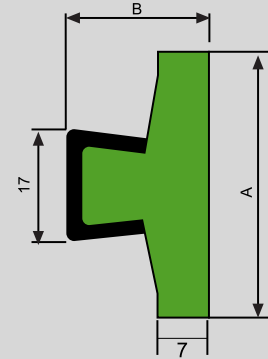
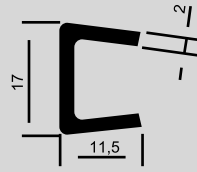
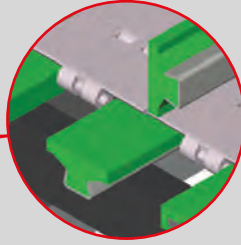
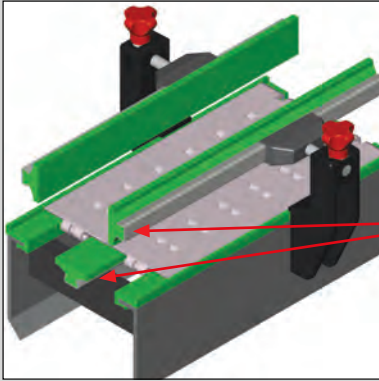

Profil Bölümü/Profiles: "Konik/Conical"

L: Standart Uzunluk (metre)/Standart Length (meter)

	Kılavuz Guide	L	A	B	Kg/m	Stok Kod Stock Code		
Alpolen® 1000 - Yeşil / Green	C 1711 SS	2	40	21	0,88	206 AY1 101		
Alpolen® 1000 - Siyah / Black						206 AY1 102		
Alpolen® 1000 - Yeşil / Green	C 1711 ZN					206 AY1 201		
Alpolen® 1000 - Siyah / Black						206 AY1 202		
Alpolen® 1000 - Yeşil / Green	C 1711 SS		50		21	0,95	206 AY2 101	
Alpolen® 1000 - Siyah / Black							206 AY2 102	
Alpolen® 1000 - Yeşil / Green	C 1711 ZN						206 AY2 201	
Alpolen® 1000 - Siyah / Black							206 AY2 202	
Alpolen® 1000 - Yeşil / Green	C 1711 SS		60			21	1,02	206 AY3 101
Alpolen® 1000 - Siyah / Black								206 AY3 102
Alpolen® 1000 - Yeşil / Green	C 1711 ZN							206 AY3 201
Alpolen® 1000 - Siyah / Black								206 AY3 202

"AY" ALT YATAKLAMA VE YAN DESTEK PROFİLİ/CHAIN GUIDES AND FRICTION PROFILES

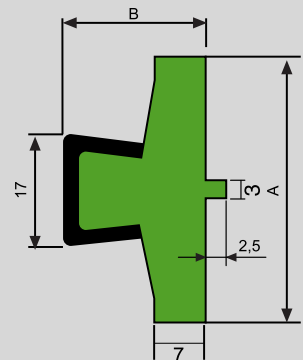
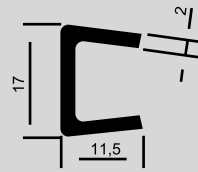
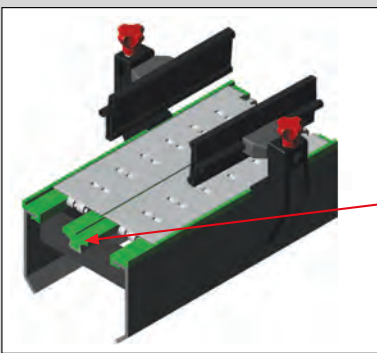

Profil Bölümü/Profiles: "Konik/Conical"

L: Standart Uzunluk (metre)/Standart Length (meter)

	Kılavuz Guide	L	A	B	Kg/m	Stok Kod Stock Code
Alpolen® 1000 - Yeşil / Green	C 1711 SS	2	43	21	0,89	206 AY4 101
Alpolen® 1000 - Siyah / Black						206 AY4 102
Alpolen® 1000 - Yeşil / Green	C1711 ZN					206 AY4 201
Alpolen® 1000 - Siyah / Black						206 AY4 202

Çağrı End. A.Ş. gerekli gördüğü takdirde, teknik gelişmeler neticesinde kataloğtaki çizim ve değerler üzerinde haber vermeksizin değişiklik yapma hakkına sahiptir.

Çağrı Endüstri is reserved the right to update the technical specifications and values in this catalogue at any time without prior notice.

*Özel üretim yapılır. / On request special production is available.



SİLİNDİRİK KULAKLI PROFİL ALPOLEN® 1000/GUIDES FOR BOTTLING AND PACKAGING

B



Profil Bölümü/Profiles: "Konik/Conical"		L: Standart Uzunluk (metre)/Standart Length (meter)	
	L	Kg/m	Stok Kod Stock Code
Alpolen® 1000 - Yeşil / Green	2/6	0,77	207 YD1 001
Alpolen® 1000 - Siyah / Black			207 YD1 002

YARIM SİLİNDİR KULAKLI PROFİL ALPOLEN® 1000/GUIDES FOR BOTTLING AND PACKAGING

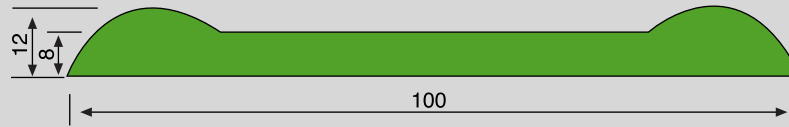

Profil Bölümü/Profiles: "Konik/Conical"		L: Standart Uzunluk (metre)/Standart Length (meter)	
	L	Kg/m	Stok Kod Stock Code
Alpolen® 1000 - Yeşil / Green	2	0,76	207 YD2 001
Alpolen® 1000 - Siyah / Black			207 YD2 002

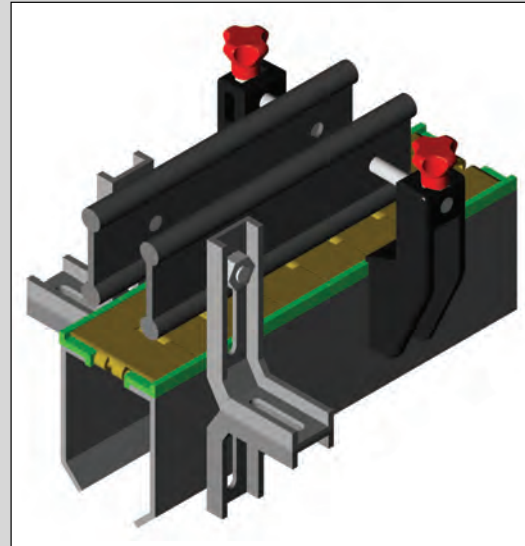
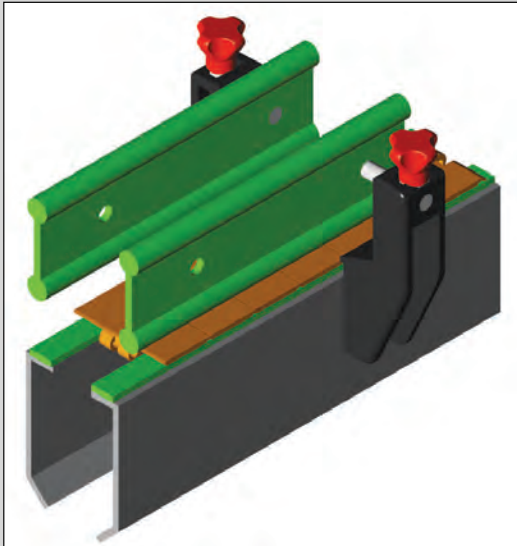

Çağrı End. A.Ş. gerekli gördüğü takdirde, teknik gelişmeler neticesinde kataloğtaki çizim ve değerler üzerinde haber vermeksizin değişiklik yapma hakkına sahiptir.

Çağrı Endüstri is reserved the right to update the technical specifications and values in this catalogue at any time without prior notice.

*Özel üretim yapılır. / On request special production is available.



B U/650 PROFİL ALPOLEN® 1000/GUIDES FOR BOTTLING AND PACKAGING

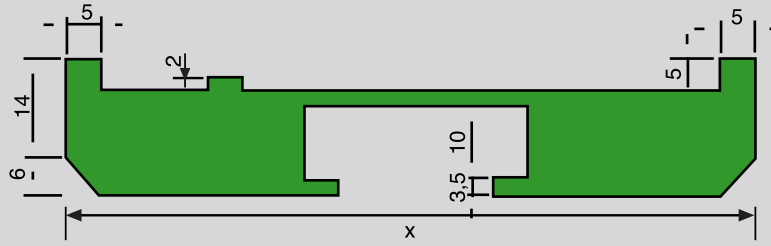

Profil Bölümü/Profiles: "Konik/Conical" L: Standart Uzunluk (metre)/Standart Length (meter)

	L	Kg/m	Stok Kod Stock Code
M			
Alpolen® 1000 - Yeşil / Green	2	-	207 OFC 001
Alpolen® 1000 - Siyah / Black			207 OFC 002

SİLİNDİRİK C PROFİL ALPOLEN® 1000/GUIDES FOR BOTTLING AND PACKAGING

Profil Bölümü/Profiles: "Konik/Conical" L: Standart Uzunluk (metre)/Standart Length (meter)

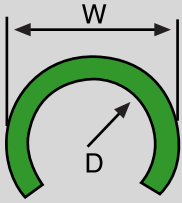

	Açıklama Characteristic	W	D	L	Kg/m	Stok Kod Stock Code
M						
Alpolen® 1000 - Beyaz / White						206 OOC B12
Alpolen® 1000 - Yeşil / Green	Ø12 mm. 1/2"	16,5	12		0,08	206 OOC Y12
Alpolen® 1000 - Siyah / Black						206 OOC S12
Alpolen® 1000 - Beyaz / White						206 OOC B10
Alpolen® 1000 - Yeşil / Green	Ø10 mm. 3/8"	13,8	10	50	0,07	206 OOC Y10
Alpolen® 1000 - Siyah / Black						206 OOC S10
Alpolen® 1000 - Beyaz / White						206 OOC B08
Alpolen® 1000 - Yeşil / Green	Ø08 mm. 5/16"	13	8		0,06	206 OOC Y08
Alpolen® 1000 - Siyah / Black						206 OOC S08

SİLİNDİRİK KULAKLI C PROFİL ALPOLEN® 1000/GUIDES FOR BOTTLING AND PACKAGING

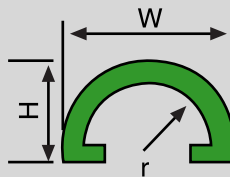

Profil Bölümü/Profiles: "Konik/Conical" L: Standart Uzunluk (metre)/Standart Length (meter)

	Açıklama Characteristic	W	H	r	L	Kg/m	Stok Kod Stock Code
M							
Alpolen® 1000 - Beyaz / White							206 ODC B10
Alpolen® 1000 - Yeşil / Green	Ø10 mm. 3/8"	25	15			0,10	206 ODC Y10
Alpolen® 1000 - Siyah / Black				50	50		206 ODC S10
Alpolen® 1000 - Beyaz / White			3				206 ODC B08
Alpolen® 1000 - Yeşil / Green	Ø08 mm. 5/16"	20	13			0,09	206 ODC Y08
Alpolen® 1000 - Siyah / Black							206 ODC S08

Çağrı End. A.Ş. gerekli gördüğü takdirde, teknik gelişmeler neticesinde kataloğtaki çizim ve değerler üzerinde haber vermeksizin değişiklik yapma hakkına sahiptir.

Çağrı Endüstri is reserved the right to update the technical specifications and values in this catalogue at any time without prior notice.

*Özel üretim yapılır. / On request special production is available.



EĞİK PROFİL ALPOLEN® 1000/GUIDES FOR BOTTLING AND PACKAGING

B

Profil Bölümü/Profiles: "L"		L: Standart Uzunluk (metre)/Standart Length (meter)				
			Kılavuz Guide	L (m)	Kg/m	Stok Kod Stock Code
ALPOLEN® Yeşil/ALPOLEN® Green			-	2	0,12	207 LFC 020
ALPOLEN® Siyah/ALPOLEN® Black			-			207 LFC 030
ALPOLEN® Yeşil/ALPOLEN® Green		C 2010 SS			0,61	207 LFC P20
ALPOLEN® Siyah/ALPOLEN® Black						207 LFC P30
ALPOLEN® Yeşil/ALPOLEN® Green		C 2010 ZN				207 LFC C20
ALPOLEN® Siyah/ALPOLEN® Black						207 LFC C30

CHY 100 PROFİL ALPOLEN® 1000/GUIDES FOR BOTTLING AND PACKAGING

Profil Bölümü/Profiles: "C"		L: Standart Uzunluk (metre)/Standart Length (meter)					
		H	W	ØD	L (m)	Kg/m	Stok Kod Stock Code
ALPOLEN® 1000 Yeşil		20	14	8	2	0,19	207 CHY 008
ALPOLEN® 1000 Green		22	16	10		0,22	207 CHY 010
		24	18	12		0,25	207 CHY 012

KHY PROFİL ALPOLEN® 1000/GUIDES FOR BOTTLING AND PACKAGING

Profil Bölümü/Profiles: "C"		L: Standart Uzunluk (metre)/Standart Length (meter)					
		H	W	ØD	L (m)	Kg/m	Stok Kod Stock Code
ALPOLEN® 1000 Yeşil		20	14	8	2	0,21	207 KHY K08
ALPOLEN® 1000 Green		22	16	10		0,25	207 KHY K10
		24	18	12		0,29	207 KHY K12

KLAVUZLU ÖZEL 051 PROFİL ALPOLEN® 1000/GUIDES FOR BOTTLING AND PACKAGING

Profil Bölümü/Profiles: "L"		L: Standart Uzunluk (metre)/Standart Length (meter)				
			Kılavuz Guide	L	Kg/m	Stok Kod Stock Code
Alpoen® 1000 - Yeşil / Green			A 12051	2,3	0,08	206 A51 Y01
Alpoen® 1000 - Siyah / Black					0,32	206 A51 S01
Alpoen® 1000 - Beyaz / White					0,08	206 A51 B01

KLAVUZLU ÖZEL 052 PROFİL ALPOLEN® 1000/GUIDES FOR BOTTLING AND PACKAGING

Profil Bölümü/Profiles: "L"		L: Standart Uzunluk (metre)/Standart Length (meter)				
			Kılavuz Guide	L	Kg/m	Stok Kod Stock Code
Alpoen® 1000 - Yeşil / Green			A 12052	2	0,45	206 A52 Y01
Alpoen® 1000 - Siyah / Black						206 A52 S01
Alpoen® 1000 - Beyaz / White						206 A52 B01
Alpoen® 1000 - Yeşil / Green			0,43	0,43	0,43	206 A52 Y02
Alpoen® 1000 - Siyah / Black						206 A52 S02
Alpoen® 1000 - Beyaz / White						206 A52 B02
Alpoen® 1000 - Yeşil / Green			0,57	0,57	0,57	206 A52 Y03
Alpoen® 1000 - Siyah / Black						206 A52 S03
Alpoen® 1000 - Beyaz / White						206 A52 B03

Çağrı End. A.Ş. gerekli gördüğü takdirde, teknik gelişmeler neticesinde katalogtaki çizim ve değerler üzerinde haber vermeksizin değişiklik yapma hakkına sahiptir.

Çağrı Endüstri is reserved the right to update the technical specifications and values in this catalogue at any time without prior notice.

*Özel üretim yapılır. / On request special production is available.



B T 100 PROFİL ALPOLEN® 1000/GUIDES FOR BOTTLING AND PACKAGING

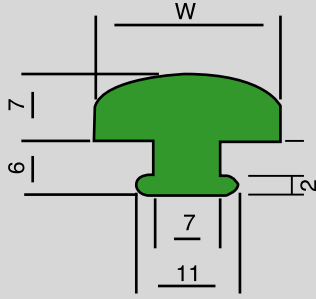

Profil Bölümü/Profiles: "T"

L: Standart Uzunluk (metre)/Standart Length (meter)

M	W	L	Kg/m	Stok Kod
				Stock Code
Alpolen® 1000 - Yeşil / Green	20	2	0,17	206 OT1 001
Alpolen® 1000 - Siyah / Black				206 OT1 002
Alpolen® 1000 - Yeşil / Green	30			206 OT1 003
Alpolen® 1000 - Siyah / Black				206 OT1 004

T 200 PROFİL ALPOLEN® 1000/GUIDES FOR BOTTLING AND PACKAGING

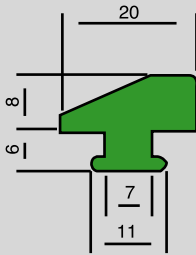

Profil Bölümü/Profiles: "T"

L: Standart Uzunluk (metre)/Standart Length (meter)

M	L	Kg/m	Stok Kod
			Stock Code
Alpolen® 1000 - Yeşil / Green	2	0,19	206 YT2 001
Alpolen® 1000 - Siyah / Black			206 YT2 002

YARIM T PROFİL ALPOLEN® 1000/PROFILES OF BEVEL CHANNEL

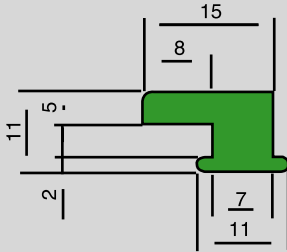

Profil Bölümü/Profiles: "T"

L: Standart Uzunluk (metre)/Standart Length (meter)

M	L	Kg/m	Stok Kod
			Stock Code
Alpolen® 1000 - Yeşil / Green	2	0,10	206 YT1 001
Alpolen® 1000 - Siyah / Black			206 YT1 002

T 300 PROFİL ALPOLEN® 1000/GUIDES FOR BOTTLING AND PACKAGING

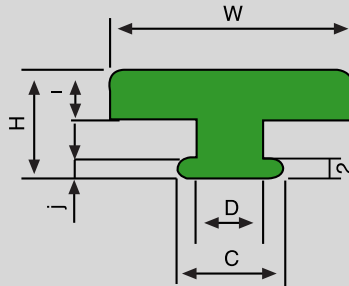

Profil Bölümü/Profiles: "T"

L: Standart Uzunluk (metre)/Standart Length (meter)

M	W	C	H	D	J	I	L	Kg/m	Stok Kod
									Stock Code
Alpolen® 1000 - Yeşil / Green	20	11	11	7	2	5	2	0,16	206 T20 001
Alpolen® 1000 - Siyah / Black									206 T20 002
Alpolen® 1000 - Yeşil / Green	25	11	11	7	2	5	2	0,18	206 T25 001
Alpolen® 1000 - Siyah / Black									206 T25 002
Alpolen® 1000 - Yeşil / Green	30	11	11	7	2	5	2	0,18	206 T30 001
Alpolen® 1000 - Siyah / Black									206 T30 002
Alpolen® 1000 - Yeşil / Green	25	11	10	7	2	4	2	0,15	206 T25 101
Alpolen® 1000 - Siyah / Black									206 T25 102

Çağrı End. A.Ş. gerekli gördüğü takdirde, teknik gelişmeler neticesinde kataloğtaki çizim ve değerler üzerinde haber vermeksizin değişiklik yapma hakkına sahiptir.

Çağrı Endüstri is reserved the right to update the technical specifications and values in this catalogue at any time without prior notice.

*Özel üretim yapılır. / On request special production is available.



ÇAĞRI[®]
ENDÜSTRİ A.Ş.

ALHAN[®]

ZİNCİR KIZAKLARI ROLLER CHAIN GUIDES

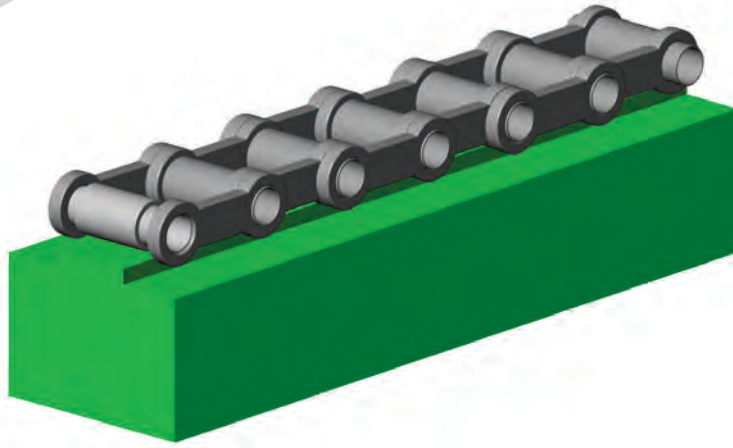

Üretimden Satış
от производства к продаже
From Production to Sales



T 400 PROFİL ALPOLEN® 1000/GUIDES FOR BOTTLING AND PACKAGING

B

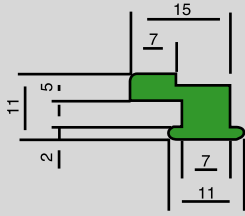

Profil Bölümü/Profiles: "T"

L: Standart Uzunluk (metre)/Standart Length (meter)

	L	Kg/m	Stok Kod Stock Code
			
Alpolen® 1000 - Yeşil / Green	2	0,11	206 KT1 001
Alpolen® 1000 - Siyah / Black			206 KT1 002

T 400 PROFİL ALPOLEN® 1000/GUIDES FOR BOTTLING AND PACKAGING

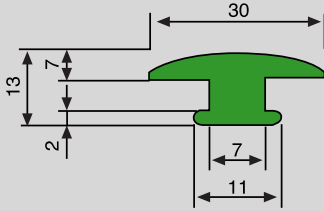

Profil Bölümü/Profiles: "T"

L: Standart Uzunluk (metre)/Standart Length (meter)

	L	Kg/m	Stok Kod Stock Code
			
Alpolen® 1000 - Yeşil / Green	2	0,24	206 KT2 001
Alpolen® 1000 - Siyah / Black			206 KT2 002

ALPOLEN® 1000 T MODEL ZİNCİR KIZAKLARI/ROLLER CHAIN GUIDES

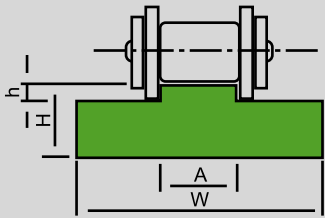
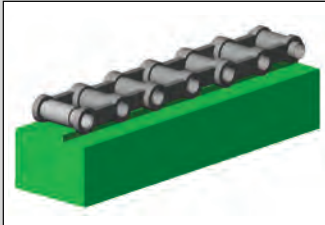

Profil Bölümü/Profiles: "T"

L: Standart Uzunluk (metre)/Standart Length (meter)

	ISO	Hatve Pitch	W	H	A	h	L	Kg/m	Stok Kod Stock Code
Alpolen® 1000 Yeşil / Green	06 B1	3/8"	15	10	5,4	1,5	2	0,135	207 OTO 038
	08 B1	1/2"	20	10	7,4	2,2		0,165	207 OTO 012
	08 B1	1/2"	20	15	7,4	2,2		0,265	207 OTO 112
	10 B1	5/8"	20	10	9,2	2,6		0,160	207 OTO 058
	10 B1	5/8"	20	15	9,2	2,6		0,260	207 OTO 158
	12 B1	3/4"	25	10	11,3	2,4		0,210	207 OTO 034
	12 B1	3/4"	25	15	11,3	2,4		0,325	207 OTO 134
	16 B1	1"	40	15	16,5	3,5		0,470	207 OTO 100
	16 B1	1"	40	20	16,5	3,5		0,660	207 OTO 101
	20 B1	1 1/4"	45	15	19,0	4,3		0,530	207 OTO 114
	20 B1	1 1/4"	45	20	19,0	4,3		0,720	207 OTO 214
	24 B1	1 1/2"	60	15	24,6	5,6		0,785	207 OTO 412
	28 B1	1 3/4"	75	20	30	6,9		1,130	207 OTO 434
	32 B1	2"	85	20	30	7,8		1,210	207 OTO 200

ALPOLEN® 1000 KANALLI T MODEL ZİNCİR KIZAKLARI/ROLLER CHAIN GUIDES

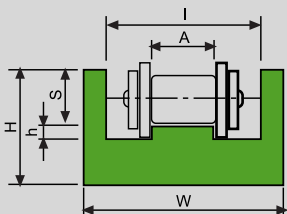

Profil Bölümü/Profiles: "T"

L: Standart Uzunluk (metre)/Standart Length (meter)

	ISO	Hatve Pitch	W	H	I	h	A	S	L	Kg/m	Stok Kod Stock Code
Alpolen® 1000 Yeşil / Green	06 B1	3/8"	25	10	15	1,5	5,4	4,4	2	0,170	207 OT2 038
	08 B1	1/2"	30	15	20	2,2	7,4	7,2		0,275	207 OT2 012
	10 B1	5/8"	33	20	23	2,6	9,2	9,5		0,405	207 OT2 058
	12 B1	3/4"	38	20	28	2,4	11,3	11,1		0,410	207 OT2 034
	16 B1	1"	51	25	41	3,5	16,5	16,5		0,510	207 OT2 100
	20 B1	1 1/4"	56	30	46	4,3	19	20,7		0,720	207 OT2 114

Çağrı End. A.Ş. gerekli gördüğü takdirde, teknik gelişmeler neticesinde katalogtaki çizim ve değerler üzerinde haber vermeksizin değişiklik yapma hakkına sahiptir.

Çağrı Endüstri is reserved the right to update the technical specifications and values in this catalogue at any time without prior notice.

*Özel üretim yapılır. / On request special production is available.



ALPOLEN® 1000 2T MODEL HAFİF TİP ZİNCİR KIZAKLARI/ROLLER CHAIN GUIDES (LIGHT TYPE)

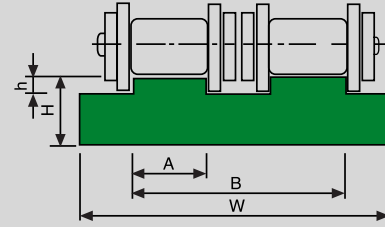
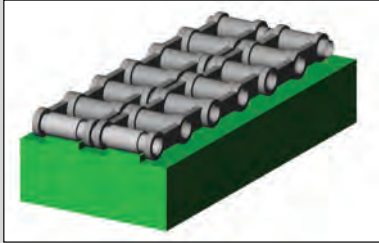

Profil Bölümü/Profiles: "T"

L: Standart Uzunluk (metre)/Standart Length (meter)

	ISO	Tipi Type	Hatve Pitch	W	H	A	h	B	L	Kg/m	Stok Kod Stock Code
Alpolen® 1000 Yeşil / Green	06 B2	Hafif Tip Light Type	3/8"	25	10	5,4	1,5	16	2	0,230	207 TH2 510
	08 B2		1/2"	35		7,4	2,2	21		0,306	207 TH3 510
	10 B2		5/8"	40	9,2	2,6	26	0,344		207 TH4 010	
			5/8"		9,2			0,524		207 TH4 015	
	12 B2		3/4"	45	10	11,3	2,4	31		0,396	207 TH4 510
	3/4"	15	11,3		0,598	207 TH4 515					

ALPOLEN® 1000 2T MODEL AĞIR TİP ZİNCİR KIZAKLARI/ROLLER CHAIN GUIDES (HEAVY TYPE)

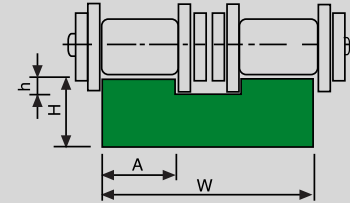
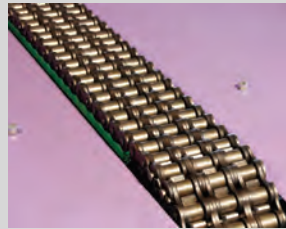
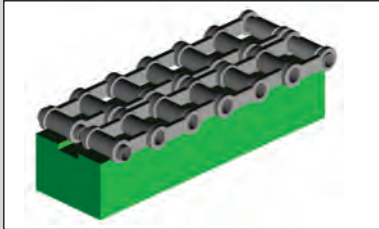

Profil Bölümü/Profiles: "T"

L: Standart Uzunluk (metre)/Standart Length (meter)

	ISO	Tipi Type	Hatve Pitch	W	H	A	h	B	L	Kg/m	Stok Kod Stock Code	
Alpolen® 1000 Yeşil / Green	16 B2	Ağır Tip Heavy Type	1"	48	15	16,5	3,5	-	2		0,863	207 TA4 815
					20		3,5				1,156	207 TA4 820
					15		4,3				0,912	207 TA5 515
	24 B2		1 1/2"	72	20	24,6	4,3				1,232	207 TA5 520
							5,6				1,499	207 TA7 220
	28 B2		1 3/4"	89	30	6,9	1,790				207 TA8 920	
	32 B2		2"	89		7,8	1,750				207 TA8 921	

"TT" ZİNCİR KIZAKLARI/"TT" ROLLER CHAIN GUIDES

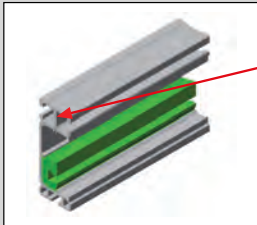

Stok Kod/Stock Code
765 045 150

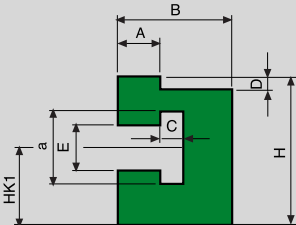
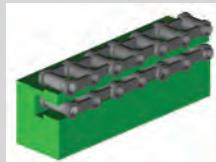

Profil Bölümü/Profiles: "TT"

L: Standart Uzunluk (metre)/Standart Length (meter)

	Hatve Pitch	a	A	C	D	E	B	H	Hq	HK1	Stok Kod Stock Code
Alpolen® 1000 Yeşil / Green	3/8"	9,5	5,4	4,6	1,5	6,6	20,0	24,4	26,9	14,5	207 OTT 001
	1/2"	13,0	7,4	5,4	2,2	8,6	20,0	26,9	29,4	15,5	207 OTT 002
	5/8"	15,5	9,2	5,6	2,6	10,4	20,0	33,8	36,2	18,5	207 OTT 003
	3/4"	17,0	11,3	6,4	2,6	12,2	28,0	37,3	40,3	21,5	207 OTT 004
	1/1"	22,0	16,5	10,5	4,2	16,0	38,0	50,5	54,0	31,5	207 OTT 005

Çağrı End. A.Ş. gerekli gördüğü takdirde, teknik gelişmeler neticesinde kataloğtaki çizim ve değerler üzerinde haber vermeksizin değişiklik yapma hakkına sahiptir.

Çağrı Endüstri is reserved the right to update the technical specifications and values in this catalogue at any time without prior notice.

*Özel üretim yapılır. / On request special production is available.

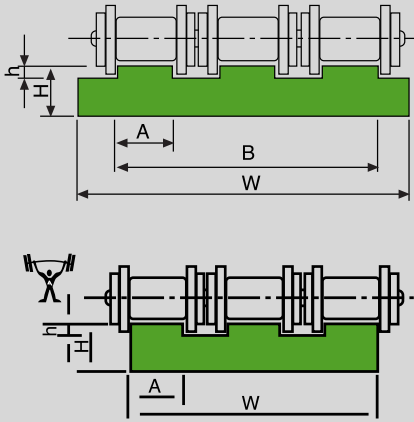
B ALPOLEN® 1000 3 SIRALI ZİNCİR KIZAKLARI/ROLLER CHAIN GUIDES (TRIPLE)

Profil Bölümü/Profiles: "3T"

L: Standart Uzunluk (metre)/Standart Length (meter)

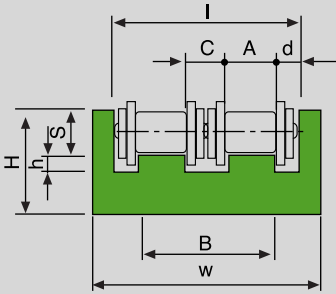
M	ISO	Hatve Pitch	W	H	A	h	B	L	Kg/m	Stok Kod
										Stock Code
Alpolen® 1000 Yeşil / Green	06 B3	3/8"	35	10	5,4	1,5	25,9	2	0,306	207 B33 510
	08 B3	1/2"	45	10	7,4	2,2	35,3		0,381	207 B34 510
	08 B3	1/2"	45	15	7,4	2,2	35,3		0,595	207 B34 515
	08 B3	1/2"	45	20	7,4	2,2	35,3		0,808	207 B34 520
	10 B3	5/8"	55	10	9,2	2,6	42,5		0,455	207 B35 510
	12 B3	3/4"	65	10	11,3	2,4	50,3		0,546	207 B36 510
Alpolen® 1000 Yeşil/Green	16 B3	1"	95	15	16,5	3,5	80,3	2	1,167	207 B39 515
	20 B3	1 1/4"	92	15	19,0	4,3	92,0		1,304	207 B39 215
	24 B3	1 1/2"	121	20	24,6	5,6	121,5		2,247	207 B31 120
	28 B3	1 3/4"	149	25	30,0	6,9	149,3		3,522	207 B31 925
	32 B3	2"	149	30	30,0	7,8	149,3		4,262	207 B31 930

ALPOLEN® 1000 "UCD" ZİNCİR KIZAKLARI/ROLLER CHAIN GUIDES "UCD"

Profil Bölümü/Profiles: "UCD"

L: Standart Uzunluk (metre)/Standart Length (meter)

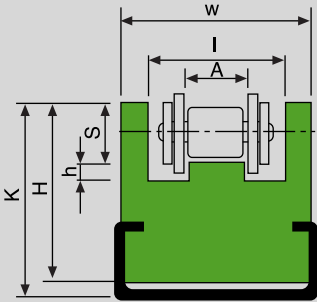
M	ISO	Hatve Pitch	W	H	I	h	A	S	B	C	d	L	Kg/m	Stok Kod
														Stock Code
Alpolen® 1000 Yeşil / Green	06 B2	3/8"	36	15	26	1,5	5,4	4,4	16	5,2	5	2	0,390	207 UCD 036
	08 B2	1/2"	45	20	35	2,2	7,4	7,2	21	6,2	7		0,620	207 UCD 045
	10 B2	5/8"	50	25	40	2,6	9,2	9,5	26	7,6	7		0,816	207 UCD 050
	12 B2	3/4"	56	25	46	2,4	11,3	11,1	31	8,4	7,5		0,810	207 UCD 056
	16 B2	1"	85	30	75	3,5	16,5	16,5	48,4	15,4	13,3		1,200	207 UCD 085

ALPOLEN® 1000 "UCC" ZİNCİR KIZAKLARI/ROLLER CHAIN GUIDES "UCC"

Profil Bölümü/Profiles: "UCC"

L: Standart Uzunluk (metre)/Standart Length (meter)

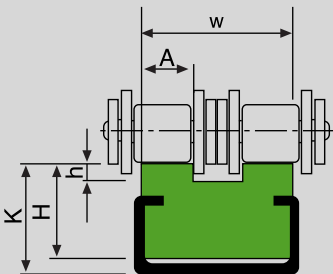
M	ISO	Hatve Pitch	Kılavuz Guide	W	H	K	I	h	A	S	L	Kg/m	Stok Kod
													Stock Code
Alpolen® 1000 Yeşil / Green	06 B1	3/8"	C 2010 ZN	25	15	18	15	1,5	5,4	4,4	2	0,760	207 UCC C25
	06 B1	3/8"	C 2010 SS	25	15	18	15	1,5	5,4	4,4		0,760	207 UCC P25
	08 B1	1/2"	C 2812 ZN	30	25	27	20	2,2	7,4	7,2		1,100	207 UCC C30
	08 B1	1/2"	C 2812 SS	30	25	27	20	2,2	7,4	7,2		1,100	207 UCC P30
	10 B1	5/8"	C 2812 ZN	33	30	32	23	2,6	9,2	9,5		1,305	207 UCC C33
	10 B1	5/8"	C 2812 SS	33	30	32	23	2,6	9,2	9,5		1,305	207 UCC P33
	12 B1	3/4"	C 3818 ZN	38	35	40	28	2,4	11,3	11,1		2,335	207 UCC C38
	12 B1	3/4"	C 3818 SS	38	35	40	28	2,4	11,3	11,1		2,335	207 UCC P38
	16 B1	1"	C 3818 ZN	51	40	45	41	3,5	16,5	16,5		2,440	207 UCC C51
	16 B1	1"	C 3818 SS	51	40	45	41	3,5	16,5	16,5		2,440	207 UCC P51

ALPOLEN® 1000 "TCG" ZİNCİR KIZAKLARI/ROLLER CHAIN GUIDES "TCG"

Profil Bölümü/Profiles: "UCC"

L: Standart Uzunluk (metre)/Standart Length (meter)

M	ISO	Hatve Pitch	Kılavuz Guide	W	H	K	h	A	L	Kg/m	Stok Kod
											Stock Code
Alpolen® 1000 Yeşil / Green	06 B2	3/8"	C 2010 ZN	15,6	10	15	1,5	5,4	2	0,615	207 TCG C38
			C 2010 SS								207 TCG P38
	08 B2	1/2"	C 2010 ZN	21,5	15	18	2,2	7,4			207 TCG C12
			C 2010 SS								207 TCG P12
	10 B2	5/8"	C 2812 ZN	26,0	15	18	2,6	9,2			207 TCG C58
			C 2812 SS								207 TCG P58
	12 B2	3/4"	C 2812 ZN	31,0	15	18	2,4	11,3			207 TCG C34
			C 2812 SS								207 TCG P34

Çağrı End. A.Ş. gerekli gördüğü takdirde, teknik gelişmeler neticesinde kataloğtaki çizim ve değerler üzerinde haber vermeksizin değişiklik yapma hakkına sahiptir.

Çağrı Endüstri is reserved the right to update the technical specifications and values in this catalogue at any time without prior notice.

*Özel üretim yapılır. / On request special production is available.



ALPOLEN® 1000 "TT" MODEL TİPİ ZİNCİR KIZAKLARI/ROLLER CHAIN GUIDES

B

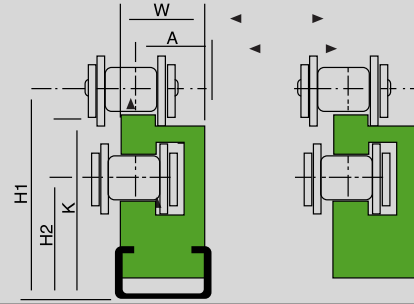
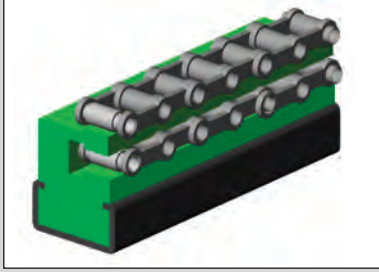

Profil Bölümü/Profiles: "TT"

L: Standart Uzunluk (metre)/Standart Length (meter)

M	ISO	Hatve Pitch	Kılavuz Guide	W	H	H1	H2	A	K	L	Kg/m	Stok Kod Stock Code
Alpolen® 1000 Yeşil / Green	06 B1	3/8"	C 2010 ZN	20	25	30	17	14,5	27	2	0,900	207 1TT C38
			C 2010 SS									207 1TT P38
	08 B1	1/2"	C 2010 ZN	28	28	34	18	16,5	30	0,950	207 1TT C12	
			C 2010 SS								207 1TT P12	
	10 B1	5/8"	C 2010 ZN	33	33	41	21	15,5	36	1,120	207 1TT C58	
			C 2010 SS								207 1TT P58	
	12 B1	3/4"	C 2812 ZN	28	37	46,5	24	18,6	41	1,700	207 1TT C34	
			C 2812 SS								207 1TT P34	
	16 B1	1"	C 3818 ZN	38	51	62	34	25	54	3,100	207 1TT C01	
			C 3818 SS								207 1TT P01	

ALPOLEN® 1000 CC MODEL TİPİ ZİNCİR KIZAKLARI/ROLLER CHAIN GUIDES

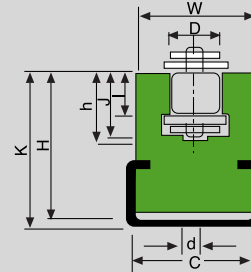
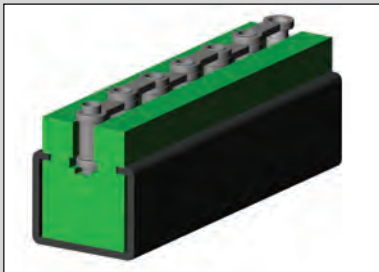

Profil Bölümü/Profiles: "UCC"

L: Standart Uzunluk (metre)/Standart Length (meter)

M	ISO	Hatve Pitch	Kılavuz Guide	W	H	K	I	J	h	d	D	C	L	Kg/m	Stok Kod Stock Code
Alpolen® 1000 Yeşil / Green	06 B	3/8"	C 2010 ZN	20	17,5	21	5,6	8,7	9,9	4	6,6	9,3	2	0,622	207 ALC 038
			C 2010 SS												207 ALP 038
	08 B	1/2"	C 2812 ZN	28	27,5	32	7,6	11,5	12,7	5	8,7	12,8	1,450	207 ALC 012	
			C 2812 SS											207 ALP 012	
	10 B	5/8"	C 2812 ZN	34	34,0	43	11,5	15,9	17,5	7	12,3	16,9	1,709	207 ALC 058	
			C 2812 SS											207 ALP 058	
	12 B	3/4"	C 3818 ZN	40	40	50	15,9	25,7	28,2	9	16,2	24,4	1,600	207 ALC 034	
			C 3818 SS											207 ALP 034	
	16 B	1"	C 3818 ZN	60	45	55	19,4	29,3	31,2	11	19,3	27,5	4,800	207 ALC 100	
			C 3818 SS											207 ALP 100	
	20 B	1 1/4"	C 6020 ZN	70	55	65	25,2	38,2	40,1	16	25,7	36,5	5,000	207 ALC 114	
			C 6020 SS											207 ALP 114	
	24 B	1 1/2"	C 6020 ZN	70	70	80	30,8	46,9	48,9	17	28,3	41,5	6,200	207 ALC 112	
			C 6020 SS											207 ALP 112	
	28 B	1 3/4"	C 6020 ZN	70	70	80	30,8	46,9	48,9	17	28,3	41,5	6,200	207 ALC 134	
			C 6020 SS											207 ALP 134	
32 B	2"	C 6020 ZN	70	70	80	30,8	47,3	53,0	19	29,6	44,5	6,200	207 ALC 200		
		C 6020 SS											207 ALP 200		

Çağrı End. A.Ş. gerekli gördüğü takdirde, teknik gelişmeler neticesinde katalogtaki çizim ve değerler üzerinde haber vermeksizin değişiklik yapma hakkına sahiptir.

Çağrı Endüstri is reserved the right to update the technical specifications and values in this catalogue at any time without prior notice.

*Özel üretim yapılır. / On request special production is available.



B ALPOLEN® 1000 CCZ MODEL ÇELİK PROFİLİ ZİNCİR KIZAKLARI/ROLLER CHAIN GUIDES

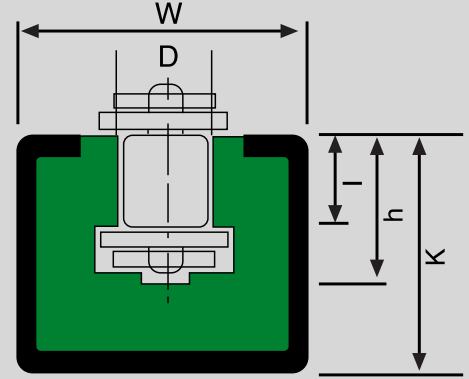
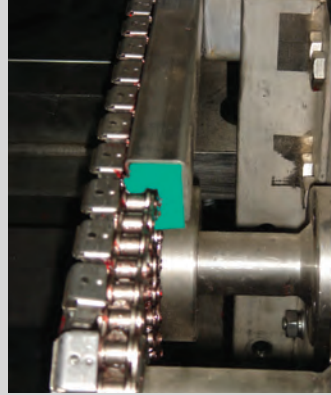

Profil Bölümü/Profiles: "CCZ"

L: Standart Uzunluk (metre)/Standart Length (meter)

M	ISO	Hatve Pitch	Kılavuz Guide	W	K	h	l	D	L	Kg/m	Stok Kod Stock Code
Alpolen® 1000 Yeşil / Green	06 B	3/8"	C 3024 ZN	30	24	10,0	5,6	6,6	2	1,375	207 CCZ 038
			C 3024 SS			10,0					207 CCZ 138
	08 B	1/2"	C 3024 ZN	28	16	12,7	7,6	8,7		1,350	207 CCZ 012
			C 3024 SS			12,7					207 CCZ 112
	08 B	1/2"	C 2816 ZN	30	24	12,7	7,6	8,7		1,260	207 CCZ 212
			C 2816 SS			12,7					207 CCZ 312
	10 B	5/8"	C 3024 ZN	45	40	14,8	9,3	10,4		1,300	207 CCZ 058
			C 3024 SS			14,8					207 CCZ 158
	12 B	3/4"	C 3024 ZN	75	75	17,5	11,5	12,3		1,260	207 CCZ 034
			C 3024 SS			17,5					207 CCZ 134
	16 B	1"	C 4540 ZN	75	75	28,2	15,9	16,2		2,930	207 CCZ 100
			C 4540 SS			28,2					207 CCZ 101

ALPOLEN® 1000 CCZ MODEL BL TİPİ ZİNCİR KIZAKLARI/ROLLER CHAIN GUIDES

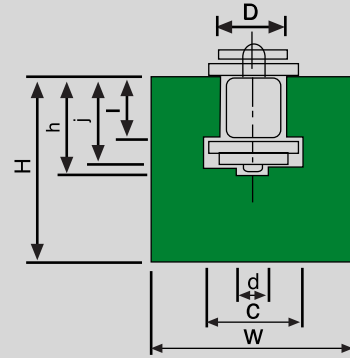
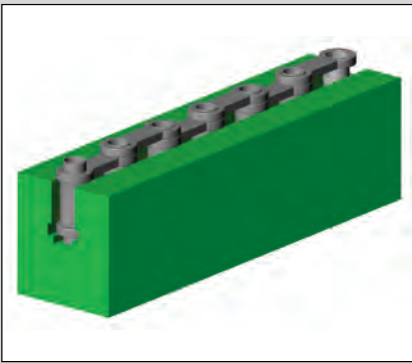

Profil Bölümü/Profiles: "UCC"

L: Standart Uzunluk (metre)/Standart Length (meter)

M	ISO	Hatve Pitch	W	H	C	h	l	D	J	d	L	Kg/m	Stok Kod Stock Code
Alpolen® 1000 Yeşil / Green	06 B	3/8" *7/32"	20	25	9,3	10	5,6	6,6	8,7	4	2	0,414	207 BLO 038
	08 B	1/2" *5/16"	24	30	12,8	12,7	7,6	8,7	11,5	5		0,564	207 BL1 012
	10 B	5/8" *3/8"	30	35	15,4	14,8	9,5	10,4	13,5	6		0,832	207 BL2 058
	12 B	3/4" *7/16"	40	35	16,9	17,5	11,5	12,3	15,9	7		1,106	207 BL3 034
	16 B	1" *17 mm	40	45	24,4	28,2	15,9	16,2	25,7	9		1,231	207 BL4 001
	20 B	1 1/4" *3/4"	50	50	27,5	31,2	19,4	19,3	29,3	11		1,726	207 BL5 114
	24 B	1 1/2" *1"	60	60	36,5	40,1	25,2	25,7	38,2	16		2,332	207 BL6 112
	28 B	1 3/4" *31 mm	70	70	41,5	48,9	30,8	28,3	46,9	17		3,173	207 BL7 134
	32 B	3/8" *7/32"	75	75	44,5	53,0	30,8	29,6	47,3	19		3,264	207 BL8 002

Çağrı End. A.Ş. gerekli gördüğü takdirde, teknik gelişmeler neticesinde katalogtaki çizim ve değerler üzerinde haber vermeksizin değişiklik yapma hakkına sahiptir.

Çağrı Endüstri is reserved the right to update the technical specifications and values in this catalogue at any time without prior notice.

*Özel üretim yapılır. / On request special production is available.



ALPOLEN® 1000 U MODEL ÇELİK PROFİLLİ KIZAKLARI/ROLLER CHAIN GUIDES

B

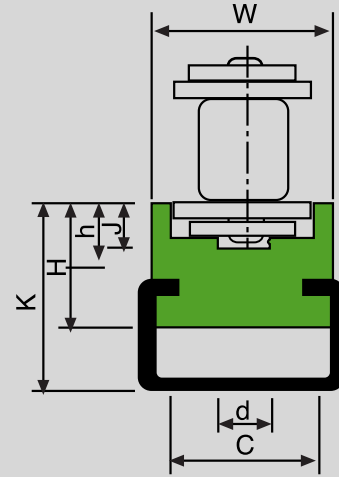
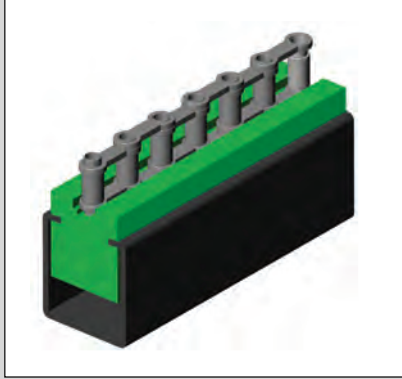

Profil Bölümü/Profiles: "TT"

L: Standart Uzunluk (metre)/Standart Length (meter)

M	ISO	Hatve Pitch	Kılavuz Guide	W	H	K	h	j	d	L	Kg/m	Stok Kod Stock Code
Alpoen® 1000 Yeşil / Green	06 B1	3/8"	C 2010 ZN	20	10	15	4,2	2,8	2,8	2	0,720	207 CUO C38
			C 2010 SS									207 CUO P38
	08 B1	1/2"	C 2010 ZN	25	15	22	4,8	3,5	3,5		1,140	207 CUO C12
			C 2010 SS									207 CUO P12
	10 B1	5/8"	C 2010 ZN	25	15	22	5,1	3,6	3,6		1,130	207 CUO C58
			C 2010 SS									207 CUO P58
	12 B1	3/4"	C 2812 ZN	35	20	27	5,7	3,9	3,9		1,270	207 CUO C34
			C 2812 SS									207 CUO P34
	16 B1	1"	C 3818 ZN	35	25	33	10	8,4	8,4		2,030	207 CUO C01
			C 3818 SS									207 CUO P01

ALPOLEN® 1000 U ZİNCİR KIZAKLARI/ROLLER CHAIN GUIDES

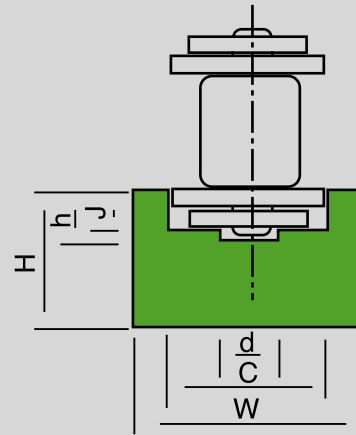
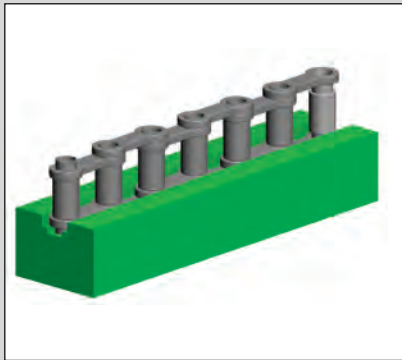

Profil Bölümü/Profiles: "U"

L: Standart Uzunluk (metre)/Standart Length (meter)

M	ISO	Hatve Pitch	W	H	C	h	J	d	L	Kg/m	Stok Kod Stock Code
Alpoen® 1000 Yeşil / Green	06 B	3/8" *7/32"	20	15	9,2	4,2	2,8	4	2	0,257	207 0U0 038
	08 B	1/2" *5/16"	25	15	12,7	4,8	3,5	5		0,308	207 0U1 012
	10 B	5/8" *3/8"	25	15	15,2	5,1	3,6	6		0,296	207 0U2 058
	12 B	3/4" *7/16"	25	20	16,7	5,7	3,9	7		0,430	207 0U3 034
	16 B	1" *17 mm	35	25	24,4	10	8,4	9		0,624	207 0U4 001

Çağrı End. A.Ş. gerekli gördüğü takdirde, teknik gelişmeler neticesinde katalogtaki çizim ve değerler üzerinde haber vermeksizin değişiklik yapma hakkına sahiptir.

Çağrı Endüstri is reserved the right to update the technical specifications and values in this catalogue at any time without prior notice.

*Özel üretim yapılır. / On request special production is available.



B ALPOLEN® 1000 U DÜZ BANTLAR İÇİN ÇELİK PROFİLLİ ZİNCİR KIZAKLARI/STRAIGHT CHAIN GUIDES

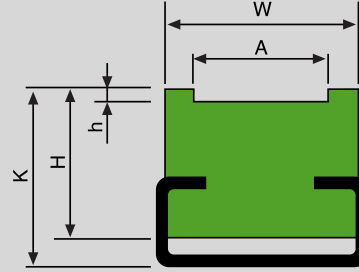
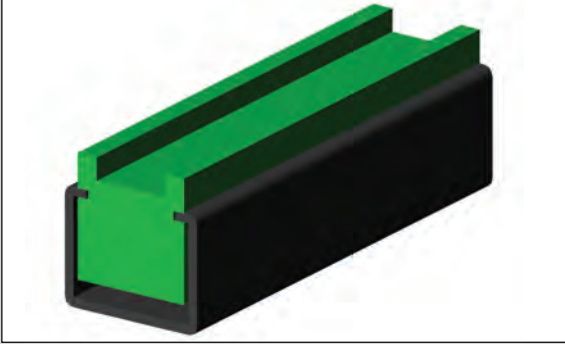

K :
H :
h :
W :
A :

Profil Bölümü/Profiles: "Konik/Conical"

L: Standart Uzunluk (metre)/Standart Length (meter)

			Kılavuz Guide	L	Kg/m	Stok Kod Stock Code
			ZN	2	-	207 TUO 001
			SS			207 TUO 002

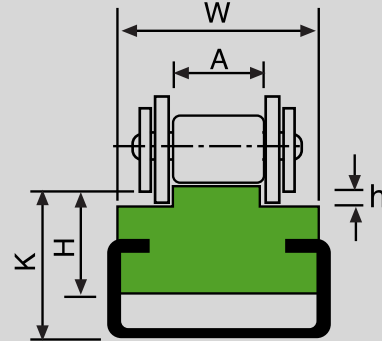
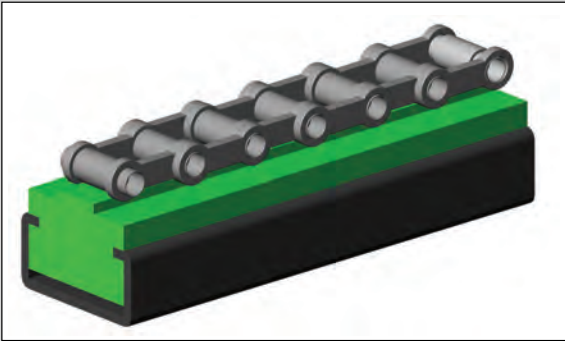

*LÜTFEN ÖLÇÜLERİ DOLDURARAK TALEPTE BULUNUNUZ. / TO MAKE AN ORDER INDICATE DIMENSIONS

ALPOLEN® 1000 T MODEL ÇELİK PROFİLLİ ZİNCİR KIZAKLARI/ROLLER CHAIN GUIDES



Profil Bölümü/Profiles: "T"

L: Standart Uzunluk (metre)/Standart Length (meter)

	ISO	Hatve Pitch		Kılavuz Guide	W	H	K	h	A	L	Kg/m	Stok Kod Stock Code
Alpolen® 1000 Yeşil / Green	06 B1	3/8"	20	C 2010 ZN	15	17	1,5	5,4	0,620	2	0,620	207 H15 038
				C 2010 SS								207 H15 038
	08 B1	1/2"	20	C 2010 ZN	15	17	2,2	7,4	0,695		207 H15 012	
				C 2010 SS							207 H15 012	
	10 B1	5/8"	20	C 2010 ZN	15	17	2,6	9,2	0,700		207 H15 058	
				C 2010 SS							207 H15 058	
	12 B1	3/4"	28	C 2012 ZN	20	24	18	2,4	11,3		1,170	207 H15 034
				C 2012 SS								207 H15 034
	16 B1	1"	28	C 2012 ZN	20	24	3,5	16,5	2,245		207 H20 100	
				C 2012 SS							207 H20 101	
	20 B1	1 1/4"	38	C 2012 ZN	25	30	18	3,5	16,5		1,250	207 H15 100
				C 2012 SS								207 H15 101
	24 B1	1 1/2"	38	C 3818 ZN	25	30	4,3	19,0	2,305		207 H25 114	
				C 3818 SS							207 H25 214	
	28 B1	1 3/4"	38	C 3818 ZN	25	30	5,6	24,6	2,390		207 H25 112	
				C 3818 SS							207 H25 112	
30 B1	2"	38	C 3818 ZN	25	30	6,9	30	2,410	207 H25 134			
			C 3818 SS						207 H25 234			
32 B1	2"	38	C 3818 ZN	25	30	7,8	30	2,480	207 H25 200			
			C 3818 SS						207 H25 201			

Çağrı End. A.Ş. gerekli gördüğü takdirde, teknik gelişmeler neticesinde kataloğtaki çizim ve değerler üzerinde haber vermeksizin değişiklik yapma hakkına sahiptir.

Çağrı Endüstri is reserved the right to update the technical specifications and values in this catalogue at any time without prior notice.

*Özel üretim yapılır. / On request special production is available.



ALPOLEN® 1000 ZİNCİR KIZAKLARI/CHAIN GUIDES

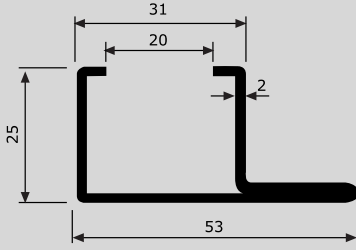

Profil Bölümü/Profiles: "C" L: Standart Uzunluk (metre)/Standart Length (meter)

Kılavuz Guide	L	Kg/m	Stok Kod Stock Code
ZN	2	1,200	207 KDC 001
SS	2	1,200	207 KDP 002

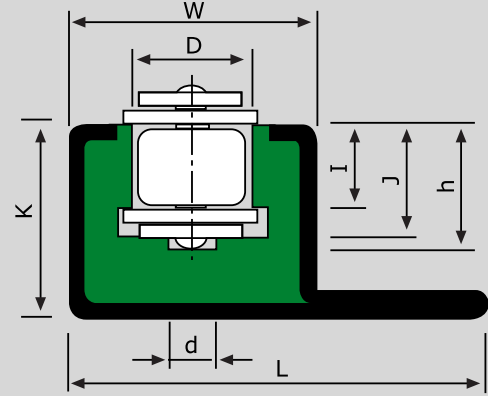

Profil Bölümü/Profiles: "L"

L: Standart Uzunluk (metre)/Standart Length (meter)

M	Kılavuz Guide	Hatve Pitch	W	K	L	I	J	h	d	D	L	Kg/m	Stok Kod Stock Code
ALPOLEN® Yeşil ALPOLEN® Green	ZN	3/8"	31	25	53	5,6	8,7	9,9	4	6,6	2	2,340	207 YDC 038
	SS	207 YDP 038											
	ZN	1/2"										2,300	207 YDC 012
	SS	207 YDP 012											
	ZN	5/8"										2,250	207 YDC 058
	SS	207 YDP 058											
	ZN	3/4"											207 YDC 034
	SS	207 YDP 034											

ALPOLEN® 1000 ZİNCİR KIZAKLARI/CHAIN GUIDES

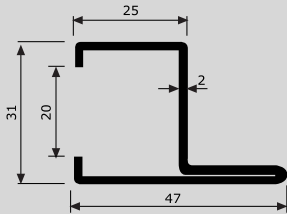

Profil Bölümü/Profiles: "C" L: Standart Uzunluk (metre)/Standart Length (meter)

Kılavuz Guide	L	Kg/m	Stok Kod Stock Code
ZN	2	1,200	207 KDC 003
SS	2	1,200	207 KDP 004

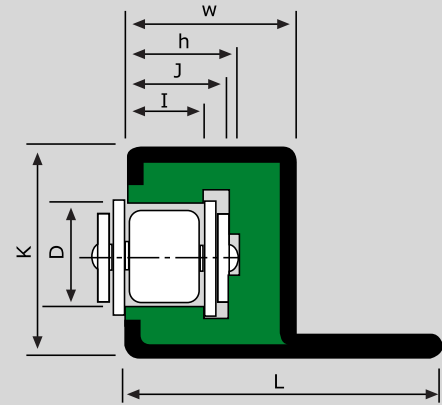

Profil Bölümü/Profiles: "L"

L: Standart Uzunluk (metre)/Standart Length (meter)

M	Kılavuz Guide	Hatve Pitch	W	K	L	I	J	h	d	D	L	Kg/m	Stok Kod Stock Code
ALPOLEN® Yeşil ALPOLEN® Green	ZN	3/8"	31	25	53	5,6	8,7	9,9	4	6,6	2	2,150	207 DYC 038
	SS	207 DYP 038											
	ZN	1/2"										2,100	207 DYC 012
	SS	207 DYP 012											
	ZN	5/8"										2,060	207 DYC 058
	SS	207 DYP 058											
	ZN	3/4"											207 DYC 034
	SS	207 DYP 034											

Çağrı End. A.Ş. gerekli gördüğü takdirde, teknik gelişmeler neticesinde katalogtaki çizim ve değerler üzerinde haber vermeksizin değişiklik yapma hakkına sahiptir.

Çağrı Endüstri is reserved the right to update the technical specifications and values in this catalogue at any time without prior notice.

*Özel üretim yapılır. / On request special production is available.



B ALPOLEN® 1000 ÇELİK PROFİLLİ KAYIŞ KLAVUZLARI / CABLE AND BELT GUIDES

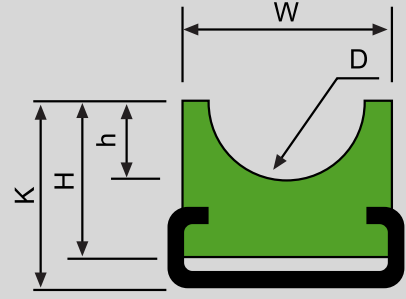

Profil Bölümü/Profiles: "L"

L: Standart Uzunluk (metre)/Standart Length (meter)

M	Kılavuz Guide	W	H	h	K	D	L	Kg/m	Stok Kod Stock Code
Alpolen® 1000 Yeşil / Green	C 2010 ZN	20	10	2	14	4	2	0,680	207 CCO 004
	C 2010 SS			5		207 CPO 004			
	C 2010 ZN			2,5		5		207 CCO 005	
	C 2010 SS			3		6		207 CPO 005	
	C 2010 ZN			3		6		207 CCO 006	
	C 2010 SS			4		8		207 CPO 006	
	C 2010 ZN	28	15	4	18	8		0,650	207 CCO 008
	C 2010 SS			5		10		207 CPO 008	
	C 2812 ZN			5		10		1,179	207 CCO 010
	C 2812 SS			6		12		1,140	207 CPO 010
	C 2812 ZN			6		12		1,140	207 CCO 012
	C 2812 SS			7,5		15		1,160	207 CPO 012
	C 2812 ZN	24	10	10	24	20		1,160	207 CCO 015
	C 2812 SS							1,280	207 CPO 015
	C 2812 ZN							1,280	207 CCO 020
	C 2812 SS							1,280	207 CPO 020

ALPOLEN® 1000 ÇELİK PROFİLLİ "V" KAYIŞ KLAVUZLARI / "V"-BELT GUIDES

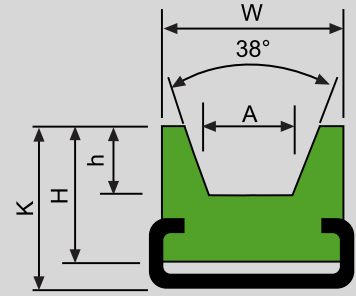

Profil Bölümü/Profiles: "L"

L: Standart Uzunluk (metre)/Standart Length (meter)

M	Kılavuz Guide	W	H	h	K	A	L	Kg/m	Stok Kod Stock Code
Alpolen® 1000 Yeşil / Green	C 2010 ZN	20	15	3	17	6,5	2	0,787	207 VCO 004
	C 2010 SS								10
	C 2010 ZN			5		13		0,782	207 VCO 005
	C 2010 SS			8		17		207 VPO 005	
	C 2812 ZN	25	20	5	24	10		1,352	207 VCO 006
	C 2812 SS								17
	C 2812 ZN	30	20	8	24	10,5		1,439	207 VCO 008
	C 2812 SS								20
	C 3818 ZN	38	25	11	32	13,5		2,265	207 VCO 010
	C 3818 SS								22
	C 3818 ZN	40	30	13	32	19		2,574	207 VCO 012
	C 3818 SS								30

Çağrı End. A.Ş. gerekli gördüğü takdirde, teknik gelişmeler neticesinde kataloğtaki çizim ve değerler üzerinde haber vermeksizin değişiklik yapma hakkına sahiptir.

Çağrı Endüstri is reserved the right to update the technical specifications and values in this catalogue at any time without prior notice.

*Özel üretim yapılır. / On request special production is available.



ALPOLEN® 1000 “V” KAYIŞ KIZAKLARI/ROLLERCHAIN GUIDES

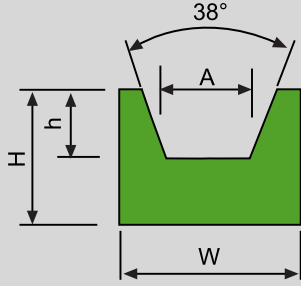

Profil Bölümü/Profiles: “CTV” L: Standart Uzunluk (metre)/Standart Length (meter)

M	W	H	h	A		L	Kg/m	Stok Kod Stock Code
Alpolen® 1000 Yeşil / Green	20	10	3	6,5	8	2	0,197	207 CTV 020
	20	12	5	8	10		0,232	207 CTV 120
	25	12	5	10	13		0,292	207 CTV 025
	30	15	8	10,5	17		0,429	207 CTV 030
	35	20	11	13,5	20		0,660	207 CTV 035
	40	25	13	19	30		0,944	207 CTV 040

ALPOLEN® 1000 “CTO” KAYIŞ KIZAKLARI/“CTO” BELT GUIDES

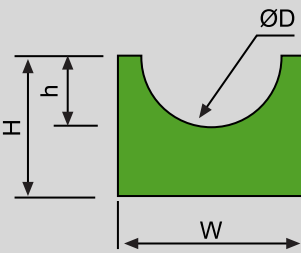

Profil Bölümü/Profiles: “CTO” L: Standart Uzunluk (metre)/Standart Length (meter)

M	W	H	h	ØD	L	Kg/m	Stok Kod Stock Code
Alpolen® 1000 Yeşil / Green	15	10	4	2	2	0,144	207 CTO 015
			5	2,5		0,140	207 CTO 115
			6	3		0,186	207 CTO 020
	20	12	8	4		0,175	207 CTO 120
			10	5		0,260	207 CTO 025
			12	6		0,244	207 CTO 125
	25	15	15	7,5		0,286	207 CTO 225
			20	10		0,442	207 CTO 030
			20	10			

ALPOLEN® 1000 “YD1” KAYIŞ KIZAKLARI/ “YD1” BELT GUIDES

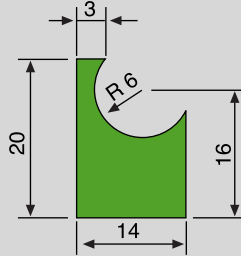

Profil Bölümü/Profiles: “YD1” L: Standart Uzunluk (metre)/Standart Length (meter)

M	L	Kg/m	Stok Kod Stock Code
Alpolen® 1000 - Yeşil / Green	2	0,18	207 CY1 001

ALPOLEN® 1000 “YD2” KAYIŞ KIZAKLARI/ “YD2” BELT GUIDES

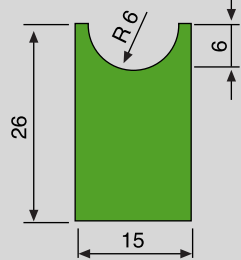

Profil Bölümü/Profiles: “YD1” L: Standart Uzunluk (metre)/Standart Length (meter)

M	L	Kg/m	Stok Kod Stock Code
Alpolen® 1000 - Yeşil / Green	2	0,34	207 CY1 002

ALPOLEN® 1000 ÖZEL KAYIŞ KIZAKLARI/ALPOLEN® 1000 SPECIAL BELT GUIDES

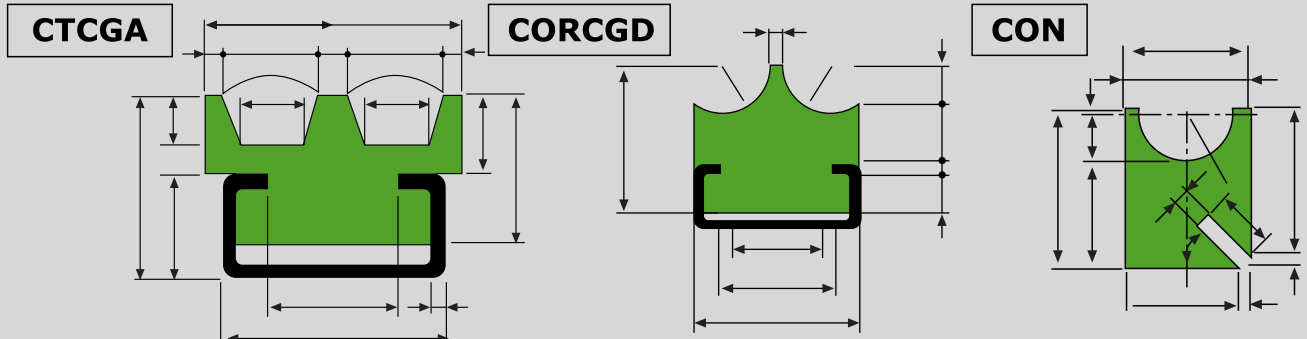

Çağrı End. A.Ş. gerekli gördüğü takdirde, teknik gelişmeler neticesinde katalogtaki çizim ve değerler üzerinde haber vermeksizin değişiklik yapma hakkına sahiptir.

Çağrı Endüstri is reserved the right to update the technical specifications and values in this catalogue at any time without prior notice.

*Özel üretim yapılır. / On request special production is available.



B ALPOLEN® 1000 "GME" SIRALI ZİNCİR KIZAKLARI/ "GME" LINK CHAIN GUIDES

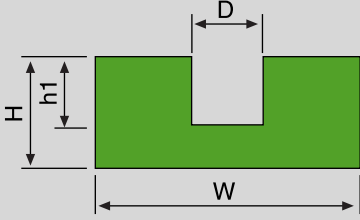

Profil Bölümü/Profiles: "GME" L: Standart Uzunluk (metre)/Standart Length (meter)

M	W	H	D	h1	L	Kg/m	Stok Kod Stock Code
Alpolen® 1000 Yeşil / Green	30	15	7	7	2	0,400	207 GME 030
	35	20	9	9		0,610	207 GME 035
	45	25	11	11		1,000	207 GME 045
	55	30	15	15		1,420	207 GME 055

ALPOLEN® 1000 "GHE" SIRALI ZİNCİR KIZAKLARI/ "GHE" LINK CHAIN GUIDES

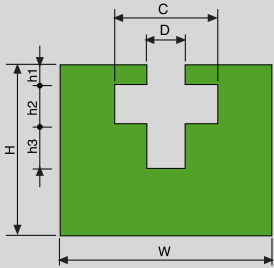

Profil Bölümü/Profiles: "GHE"

L: Standart Uzunluk (metre)/Standart Length (meter)

M	W	H	D	C	h1	h2	h3	L	Kg/m	Stok Kod Stock Code
Alpolen® 1000 Yeşil / Green	45	35	7	23	4,5	7	7	2	1,400	207 GHE 045
	50	40	9	31	5,0	9	9		1,740	207 GHE 050
	50	45	11	35	8,5	11	11		1,700	207 GHE 150
	60	50	15	47	10,5	15	15		2,145	207 GHE 060

ALPOLEN® 1000 "GH1" SIRALI ZİNCİR KIZAKLARI/ "GH1" LINK CHAIN GUIDES

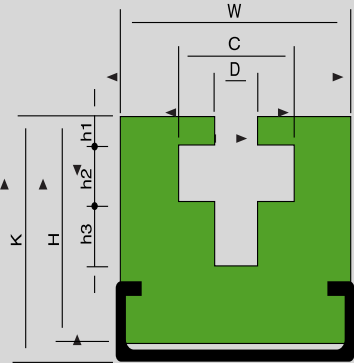

Profil Bölümü/Profiles: "GH1"

L: Standart Uzunluk (metre)/Standart Length (meter)

M	Kılavuz Guide	W	K	D	C	h1	h2	h3	L	Kg/m	Stok Kod Stock Code
Alpolen® 1000 Yeşil / Green	C 3018 ZN	45	45	7	45	4,5	7	8	2	3,200	207 GH1 C45
	C 3018 SS										207 GH1 P45
	C 3018 ZN	50	50	9	50	5,0	9	10		3,800	207 GH1 C50
	C 3018 SS										207 GH1 P50
	C 3018 ZN	50	60	11	60	8,5	11	12		3,900	207 GH1 C51
	C 3018 SS										207 GH1 P51
	C 6020 ZN	60	75	15	75	10,5	15	16		5,100	207 GH1 C60
	C 6020 SS										207 GH1 P60

ALPOLEN® 1000 "GH2" SIRALI ZİNCİR KIZAKLARI/ "GH2" LINK CHAIN GUIDES

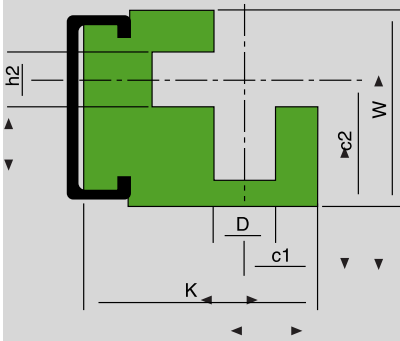

Profil Bölümü/Profiles: "GH2"

L: Standart Uzunluk (metre)/Standart Length (meter)

M	Kılavuz Guide	W	K	D	h2	c1	c2	L	Kg/m	Stok Kod Stock Code
Alpolen® 1000 Yeşil / Green	C 2010 ZN	27	34	7	7	10,5	17,5	2	1,200	207 GH2 C27
	C 2010 SS									207 GH2 P27
	C 2812 ZN	32	42	9	9	12,5	20,5		2,200	207 GH2 C32
	C 2812 SS									207 GH2 P32
	C 3818 ZN	42,5	56	11	11	16,5	25,5		3,200	207 GH2 C42
	C 3818 SS									207 GH2 P42
	C 6020 ZN	60	70	15	15	20,5	33,5		4,100	207 GH2 C60
	C 6020 SS									207 GH2 P60

Çağrı End. A.Ş. gerekli gördüğü takdirde, teknik gelişmeler neticesinde kataloğtaki çizim ve değerler üzerinde haber vermeksizin değişiklik yapma hakkına sahiptir.

Çağrı Endüstri is reserved the right to update the technical specifications and values in this catalogue at any time without prior notice.

*Özel üretim yapılır. / On request special production is available.



GEÇMELİ Z PROFİL ALPOLEN® 1000 / GUIDES FOR BOTTLING AND PACKAGING

B

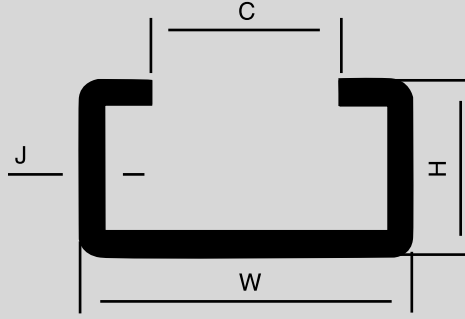
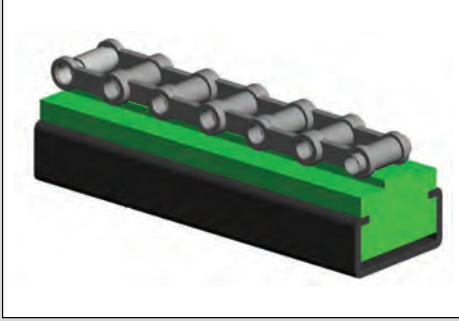

Profil Bölümü/Profiles: "C" L: Standart Uzunluk (metre)/Standart Length (meter)

Profil Guide	W	H	C	J	L	Kg/m	Stok Kod Stock Code
C 24/05 ZN	24	5,2	17,5	1	2	0,280	206 C02 405
C 24/05 SS							206 P02 405
C 20/10 ZN	20	10	10	1,5		0,490	206 C02 010
C 20/10 SS							206 P02 010
C 28/12 ZN	28	12	14	2		0,860	206 C02 812
C 28/12 SS							206 P02 812
C 28/16 ZN	28	16	14	2,5		1,160	206 C02 816
C 28/16 SS							206 P02 816
C 38/18 ZN	38	18	22	2,5		1,430	206 C03 818
C 38/18 SS							206 P03 818
C 30/24 ZN	30	24	20	1,5		0,940	206 C03 024
C 30/24 SS							206 P03 024
C 45/40 ZN	45	40	31	2		2,050	206 C04 540
C 45/40 SS							206 P04 540

ÇELİK PROFİLLER/STEEL PROFILES

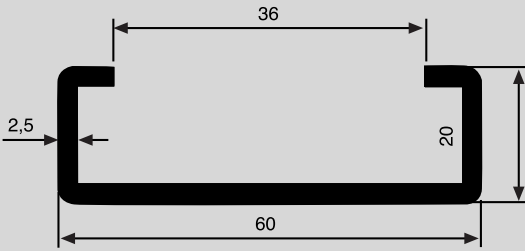

Malzeme/Material
SS: Paslanmaz Çelik/ Stainless Steel
ZN: Çinko/Zinc

Profil Bölümü/Profiles: "C" L: Standart Uzunluk (metre)/Standart Length (meter)

Profil Guide	L	Kg/m	Stok Kod Stock Code
ZN	2	2,160	206 C06 020
SS			206 P06 020

ÇELİK PROFİLLER/STEEL PROFILES

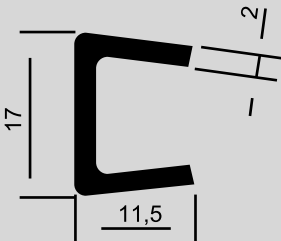

Profil Bölümü/Profiles: "C" L: Standart Uzunluk (metre)/Standart Length (meter)

Profil Guide	L	Kg/m	Stok Kod Stock Code
ZN	2	0,468	206 C17 011
SS			206 P17 011

Çağrı End. A.Ş. gerekli gördüğü takdirde, teknik gelişmeler neticesinde kataloğtaki çizim ve değerler üzerinde haber vermeksizin değişiklik yapma hakkına sahiptir.

Çağrı Endüstri is reserved the right to update the technical specifications and values in this catalogue at any time without prior notice.

*Özel üretim yapılır. / On request special production is available.



B ALPOLEN® YARI MAMUL PLAKALAR/ALPOLEN® SHEETS AND BARS

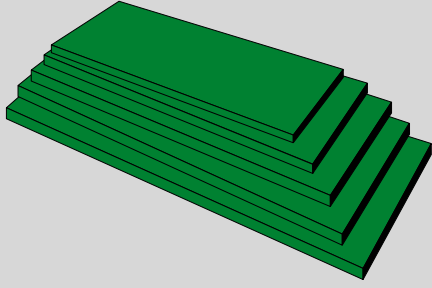

ÖLÇÜLER/DIMENSIONS: 2000 X 1000 mm
KALINLIK/THICKNESS: 2-150 mm
RENKLER/COLOURS:
YEŞİL-SİYAH-BEYAZ/GREEN-BLACK-WHITE

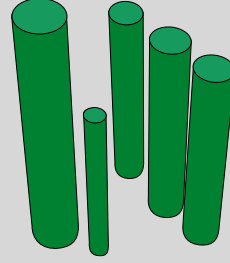

ÖLÇÜLER/DIMENSIONS: Ø20-Ø300 mm
UZUNLUK/LENGTH: 1000 mm
RENKLER/COLOURS:
YEŞİL-SİYAH-BEYAZ/GREEN-BLACK-WHITE

PVC KENAR DAYAMA PROFİLİ/PVC SIDE GUIDES

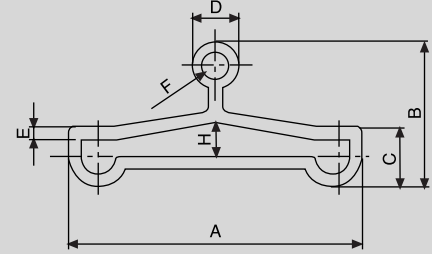
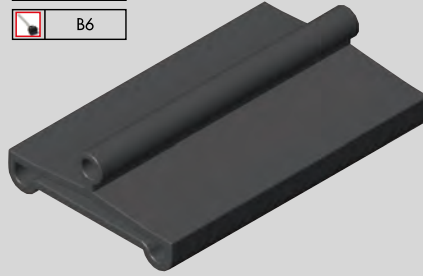
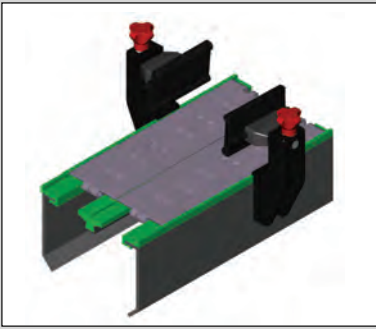

Profil Bölümü/Profiles: "YD4"

L: Standart Uzunluk (metre)/Standart Length (meter)

M	A	B	C	D	E	F	H	L	Stok Kod Stock Code
	PVC Siyah / Black	60	29	12	9	2,5	5,5	6,5	3 6

DOĞRUSAL YATAKLAR (863 SERİSİ)/STRAIGHT TRACK (FOR 863 SERIES)

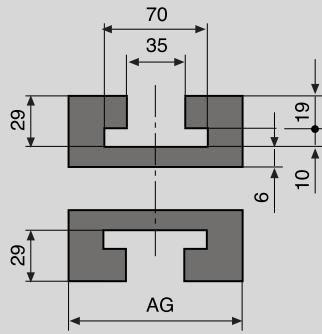
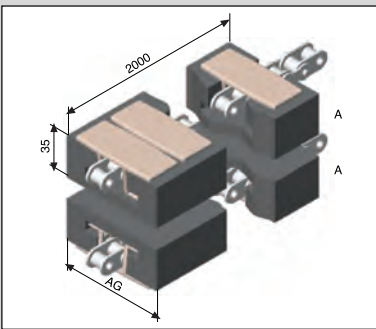

1 SET = GİDİŞ + DÖNÜŞ
1 SET = CARRY + RETURN
1 SET = 4 m



Profil Bölümü/Profiles: "YD4"

L: Standart Uzunluk (metre)/Standart Length (meter)

M	Bant Geniřlięi Chain Width	AG	Stok Kod Stock Code
	Alpoen® 1000 Siyah / Black	82,6	100
114,3		130	202 863 114
190,5		200	202 863 190
254,0		270	202 863 254
304,8		320	202863 304

Çaęrı End. A.Ş. gerekli gördüęü takdirde, teknik geliřmeler neticesinde katalogtaki çizim ve deęerler üzerinde haber vermeksizin deęiřlik yapma hakkına sahiptir.

Çaęrı Endüstri is reserved the right to update the technical specifications and values in this catalogue at any time without prior notice.

*Özel üretim yapılır. / On request special production is available.



ÇAĞRI[®]
ENDÜSTRİ A.Ş.

ALHAN[®]

DOĞRUSAL YATAKLAR STRAIGHT TRACK

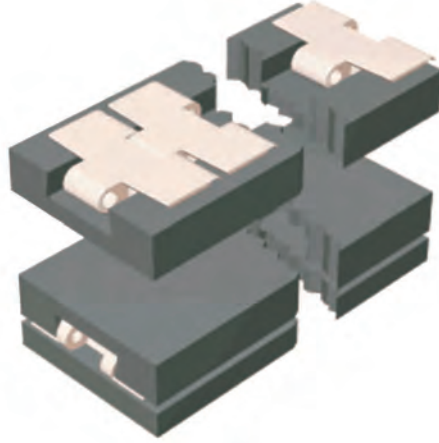

Üretimden Satış
от производства к продаже
From Production to Sales



B ALPOLEN® 1000 DOĞRUSAL YATAKLARI 880-881 BANTLAR İÇİN/ STRAIGHT TRACK (For 880-881 Chains)

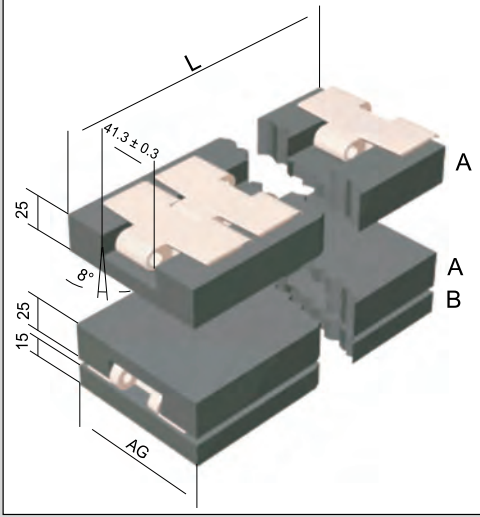

Profil Bölümü/Profiles: "C" L: Standart Uzunluk (metre)/Standart Length (meter)

	Bant Geniřliđi Chain Width	Kg/m	L (m)	Stok Kod Stock Code
Alpolen® 1000 Siyah / Black	82,6	5,00	2	202 880 082
	114,3	6,90		202 880 114
	190,5	11,35		202 880 190

1 Set = Gidiř ve Dönüş (A+A+B)/1 Set = Carry and Return (A+A+B)

ALPOLEN® 1000 DOĞRUSAL YATAKLARI 880TAB-881TAB BANTLAR İÇİN/ STRAIGHT TRACK (For 880-881 TAB Chains)

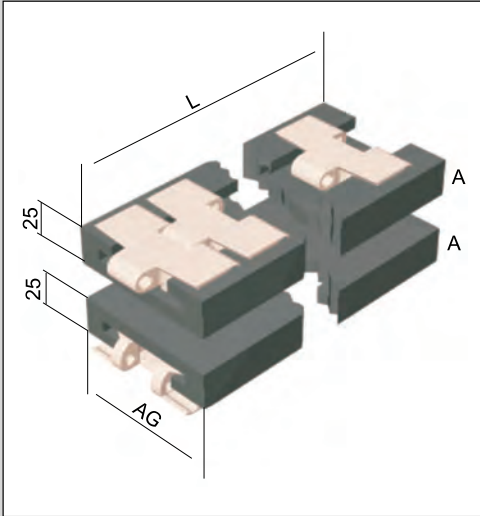

Profil Bölümü/Profiles: "C" L: Standart Uzunluk (metre)/Standart Length (meter)

	Bant Geniřliđi Chain Width	Kg/m	L (m)	Stok Kod Stock Code
Alpolen® 1000 Siyah / Black	82,6	2,95	2	202 88T 082
	114,3	4,80		202 88T 114
	190,5	7,80		202 88T 190

1 Set = Gidiř ve Dönüş (A+A+B)/1 Set = Carry and Return (A+A+B)

ALPOLEN® 1000 DOĞRUSAL YATAKLARI AđIR TİP 882 BANTLAR İÇİN/ STRAIGHT TRACK (For 882 Chains)

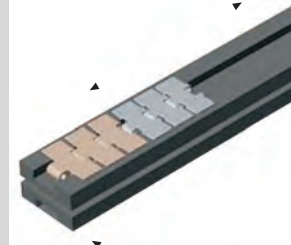
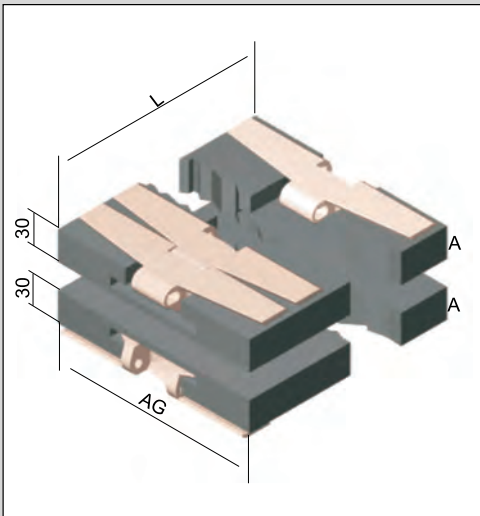

Profil Bölümü/Profiles: "C" L: Standart Uzunluk (metre)/Standart Length (meter)

	Bant Geniřliđi Chain Width	Kg/m	L (m)	Stok Kod Stock Code
Alpolen® 1000 Siyah / Black	190,5	8,65	2	202 882 190
	254,3	12,70		202 882 254
	304,8	15,65		202 882 304

Çađrı End. A.Ş. gerekli gördüđü takdirde, teknik geliřmeler neticesinde katalogtaki çizim ve deđerler üzerinde haber vermeksizin deđiřlik yapma hakkına sahiptir.

Çađrı Endüstri is reserved the right to update the technical specifications and values in this catalogue at any time without prior notice.

*Özel üretim yapılır. / On request special production is available.



ALPOLEN® 1000 90 DERECE (880 TAB-881 TAB DÖNÜŞLÜ BANTLAR İÇİN) DÖNÜŞ YATAKLARI/CURVES TRACK FOR 880 TAB-881 TAB CHAINS

B

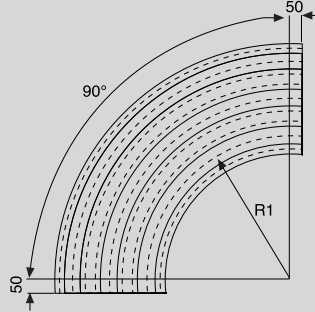
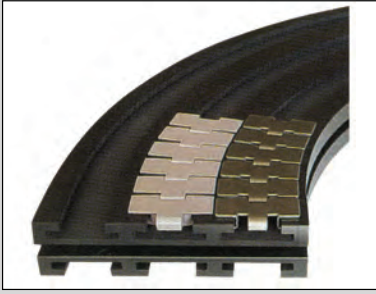

1 SET = GİDİŞ + DÖNÜŞ
1 SET = CARRY + RETURN

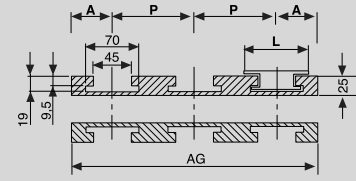

Profil Bölümü/Profiles: "C" L= 82,6 P= 84 mm

	R1	A	Sıra Track	L (m)	Stok Kod Stock Code
Alpoen® 1000 Siyah / Black	500	50	1	100	215 500 182
	500	50	2	184	215 500 282
	500	50	3	268	215 500 382
	500	50	4	352	215 500 482
	500	50	5	436	215 500 582
	500	50	6	520	215 500 682
	610	50	1	100	215 610 182
	610	50	2	184	215 610 282
	610	50	3	268	215 610 382
	610	50	4	352	215 610 482
	610	50	5	436	215 610 582
	610	50	6	520	215 610 682
	800	50	1	100	215 800 182
	800	50	2	184	215 800 282
	800	50	3	268	215 800 382
	800	50	4	352	215 800 482
	800	50	5	436	215 800 582
	800	50	6	520	215 800 682
	1000	50	1	100	215 100 182
	1000	50	2	184	215 100 282
	1000	50	3	268	215 100 382
	1000	50	4	352	215 100 482
	1000	50	5	436	215 100 582
	1000	50	6	520	215 100 682

Profil Bölümü/Profiles: "C" L= 82,6 P= 85 mm

	R1	A	Sıra Track	L (m)	Stok Kod Stock Code	
Alpoen® 1000 Siyah / Black	500	50	1	114	215 501 182	
	500	50	2	185	215 501 282	
	500	50	3	270	215 501 382	
	500	50	4	355	215 501 482	
	500	50	5	440	215 501 582	
	500	50	6	525	215 501 682	
	610	50	-	-	-	215 611 182
	610	50	2	185	215 611 282	
	610	50	3	270	215 611 382	
	610	50	4	355	215 611 482	
	610	50	5	440	215 611 582	
	610	50	6	525	215 611 682	
	800	50	-	-	-	215 801 182
	800	50	2	185	215 801 282	
	800	50	3	270	215 801 382	
	800	50	4	355	215 801 482	
	800	50	5	440	215 801 582	
	800	50	6	525	215 801 682	
	1000	50	-	-	-	215 101 182
	1000	50	2	185	215 101 282	
	1000	50	3	270	215 101 382	
	1000	50	4	355	215 101 482	
	1000	50	5	440	215 101 582	
	1000	50	6	525	215 101 682	

Profil Bölümü/Profiles: "C" L= 82,6 P= 88 mm

	R1	A	Sıra Track	AG	Stok Kod Stock Code	
Alpoen® 1000 Siyah / Black	500	50	1	-	215 502 182	
	500	50	2	188	215 502 282	
	500	50	3	276	215 502 382	
	500	50	4	364	215 502 482	
	500	50	5	452	215 502 582	
	500	50	6	540	215 502 682	
	610	50	-	-	-	215 612 182
	610	50	2	188	215 612 282	
	610	50	3	276	215 612 382	
	610	50	4	364	215 612 482	
	610	50	5	452	215 612 582	
	610	50	6	540	215 612 682	
	800	50	-	-	-	215 802 182
	800	50	2	188	215 802 282	
	800	50	3	276	215 802 382	
	800	50	4	364	215 802 482	
	800	50	5	452	215 802 582	
	800	50	6	540	215 802 682	
	1000	50	-	-	-	215 101 182
	1000	50	2	188	215 102 282	
	1000	50	3	276	215 102 382	
	1000	50	4	364	215 102 482	
	1000	50	5	452	215 102 582	
	1000	50	6	540	215 102 682	

Profil Bölümü/Profiles: "C" L= 114,3 P= 120 mm

	R1	A	Sıra Track	AG	Stok Kod Stock Code
Alpoen® 1000 Siyah / Black	500	65	1	130	215 500 114
	500	65	2	250	215 500 214
	610	65	1	130	215 610 114
	610	65	2	250	215 610 214
	800	65	1	130	215 800 114
	800	65	2	250	215 800 214
	1000	65	1	130	215 100 114
	1000	65	2	250	215 100 214

Profil Bölümü/Profiles: "C" L= 190,5 P= 196 mm

	R1	A	Sıra Track	AG	Stok Kod Stock Code
Alpoen® 1000 Siyah / Black	500	100	1	200	215 500 119
	500	100	2	396	215 500 219
	610	100	1	200	215 610 119
	610	100	2	396	215 610 219
	800	100	1	200	215 800 119
	800	100	2	396	215 800 219
	1000	100	1	200	215 100 119
	1000	100	2	396	215 100 219

Çağrı End. A.Ş. gerekli gördüğü takdirde, teknik gelişmeler neticesinde katalogtaki çizim ve değerler üzerinde haber vermeksizin değişiklik yapma hakkına sahiptir.

Çağrı Endüstri is reserved the right to update the technical specifications and values in this catalogue at any time without prior notice.

*Özel üretim yapılır. / On request special production is available.



B ALPOLLEN® 1000 90 DERECE (880 AÇILI KULAKLI BANTLAR İÇİN) DÖNÜŞ YATAKLARI/CURVES TRACK (FOR 880 CHAINS)

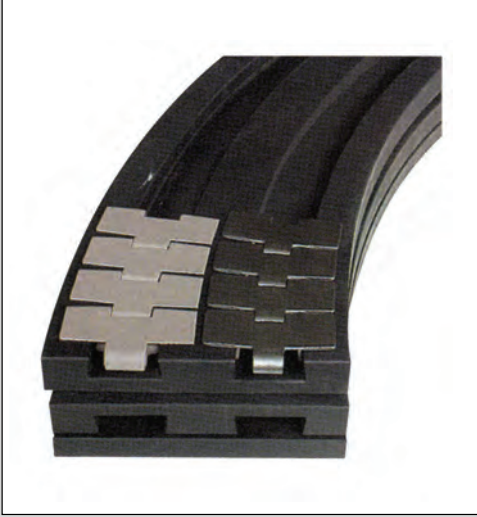

1 SET = GİDİŞ + DÖNÜŞ
1 SET = CARRY + RETURN

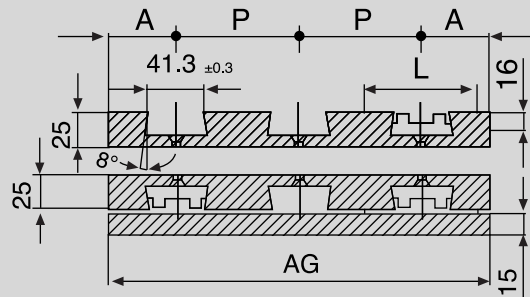
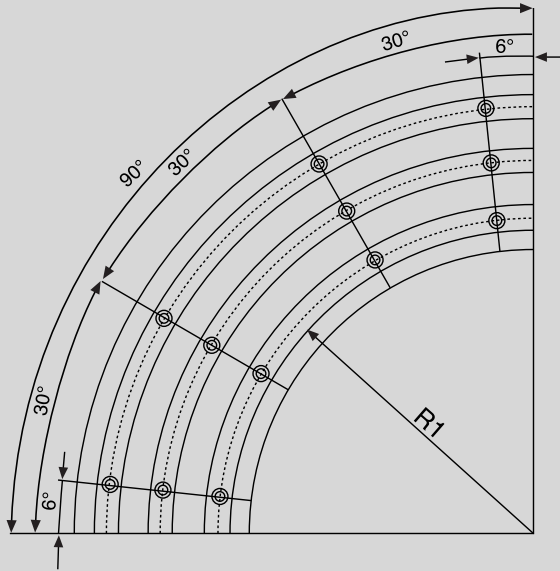

Profil Bölümü/Profiles: "C"		L= 82,6 P= 90 mm			
	R1	A	Sıra Track	AG	Stok Kod Stock Code
Alpolen® 1000 Siyah / Black	500	50	1	100	205 500 182
	500	50	2	190	205 500 282
	500	50	3	280	205 500 382
	500	50	4	370	205 500 482
	610	50	1	100	205 610 082
	650	50	1	100	205 650 182
	650	50	2	190	205 650 282
	650	50	3	280	205 650 382
	650	50	4	370	205 650 482
	860	50	1	100	205 860 281
	860	50	2	190	205 860 282
	860	50	3	280	205 860 283
860	50	4	370	205 860 284	

Profil Bölümü/Profiles: "C"		L= 114,3 P= 125 mm			
	R1	A	Sıra Track	AG	Stok Kod Stock Code
Alpolen® 1000 Siyah / Black	550	65	1	130	205 550 114
	550	65	2	255	205 550 214
	550	65	3	380	205 550 314
	550	65	4	505	205 550 414
	610	65	1	130	205 610 114
	650	65	1	130	205 650 114
	650	65	2	255	205 650 214
	650	65	3	380	205 650 314
	650	65	4	505	205 650 414

Profil Bölümü/Profiles: "C"		L= 114,3 P= 125 mm			
	R1	A	Sıra Track	AG	Stok Kod Stock Code
Alpolen® 1000 Siyah / Black	610	100	1	200	205 610 119
	650	100	1	200	205 650 119

Çağrı End. A.Ş. gerekli gördüğü takdirde, teknik gelişmeler neticesinde kataloğtaki çizim ve değerler üzerinde haber vermeksizin değişiklik yapma hakkına sahiptir.

Çağrı Endüstri is reserved the right to update the technical specifications and values in this catalogue at any time without prior notice.

*Özel üretim yapılır. / On request special production is available.



ALPOLEN® 1000 90 DERECE DÖNÜŞ YATAKLARI (882 TAB DÖNÜŞLÜ AĞIR TİP BANTLAR İÇİN)/CURVES TRACK (FOR 882 TAB CHAINS/HEAVY DUTY)

B

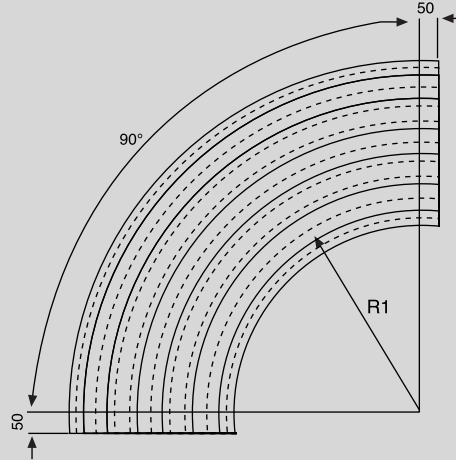

1 SET = GİDİŞ + DÖNÜŞ
1 SET = CARRY + RETURN

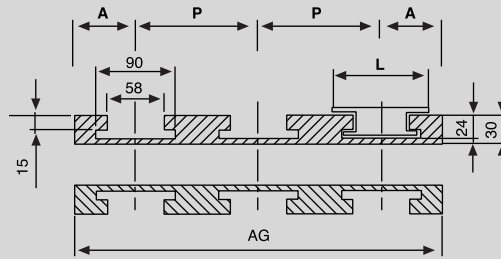

Profil Bölümü/Profiles: "C"		L= 114,3 P= 120 mm			
M	R1	A	Sıra Track	AG	Stok Kod Stock Code
Alpolet® 1000 Siyah / Black	610	65	1	130	215 610 114
	610	65	2	250	215 610 214
	800	65	1	130	215 800 114
	800	65	2	250	215 800 214
	1000	65	1	130	215 100 114
	1000	65	2	250	215 100 214
	1200	65	1	130	215 120 114
	1200	65	2	250	215 120 214

Profil Bölümü/Profiles: "C"		L= 190,5 P= 196 mm			
M	R1	A	Sıra Track	AG	Stok Kod Stock Code
Alpolet® 1000 Siyah / Black	610	100	1	200	220 610 119
	610	100	2	396	220 610 219
	800	100	1	200	220 800 119
	800	100	2	396	220 800 219
	1000	100	1	200	220 100 119
	1000	100	2	396	220 100 219
	1200	100	1	200	220 120 119
	1200	100	2	396	220 120 219

Profil Bölümü/Profiles: "C"		L= 1254 P= 260 mm			
M	R1	A	Sıra Track	AG	Stok Kod Stock Code
Alpolet® 1000 Siyah / Black	610	135	1	270	220 610 125
	610	135	2	530	220 610 225
	800	135	1	270	220 800 125
	800	135	2	530	220 800 225
	1000	135	1	270	220 100 125
	1000	135	2	530	220 100 225
	1200	135	1	270	220 120 125
	1200	135	2	530	220 120 225

Profil Bölümü/Profiles: "C"		L= 304,8 P= 310 mm			
M	R1	A	Sıra Track	AG	Stok Kod Stock Code
Alpolet® 1000 Siyah / Black	610	160	1	320	220 610 130
	610	160	2	630	220 610 230
	800	160	1	320	220 800 130
	800	160	2	630	220 800 230
	810	170	1	340	220 810 130
	1000	160	1	320	220 100 130
	1000	160	2	630	220 100 230
	1160	170	1	340	220 116 130
	1200	160	1	320	220 100 130
	1200	160	2	630	220 100 230

Çağrı End. A.Ş. gerekli gördüğü takdirde, teknik gelişmeler neticesinde katalogtaki çizim ve değerler üzerinde haber vermeksizin değişiklik yapma hakkına sahiptir.

Çağrı Endüstri is reserved the right to update the technical specifications and values in this catalogue at any time without prior notice.

*Özel üretim yapılır. / On request special production is available.



B OMURGALI (KARDENİK) BANT DÖNÜŞ TAKIMI/CURVES TRACK FOR CARDANIC CHAINS

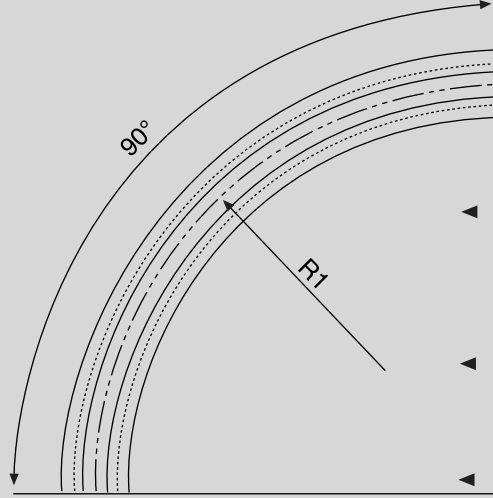

1 SET = GİDİŞ + DÖNÜŞ
1 SET = CARRY + RETURN

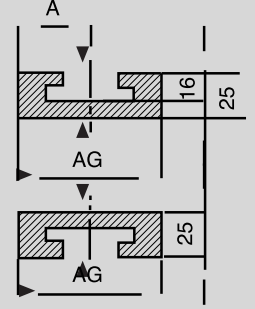

Kod	860 - 865 867 - 870 875
Say.	D22 - D23

Profil Bölümü/Profiles: "C"		L: Standart Uzunluk (metre)/Standart Length (meter)				Stok Kod Stock Code
Alpolen® 1000 Siyah / Black	865	R1	R2	R3	AG	225 150 082
		150	-	-	80	225 150 182
		215	-	-	145	225 150 282
		280	-	-	210	225 250 082
		250	-	-	80	225 500 082
500	-	-	80	225 630 082		
630	-	-	80	225 630 082		

Profil Bölümü/Profiles: "C"		L: Standart Uzunluk (metre)/Standart Length (meter)				Stok Kod Stock Code
Alpolen® 1000 Siyah / Black	860	R1	R2	R3	AG	226 150 082
		150	-	-	80	226 500 182

KASA TAŞIMA BANT KIZAKLARI/GUIDES FOR CRATE CHAINS

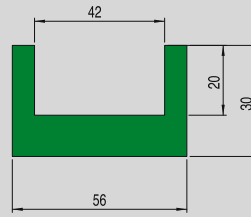
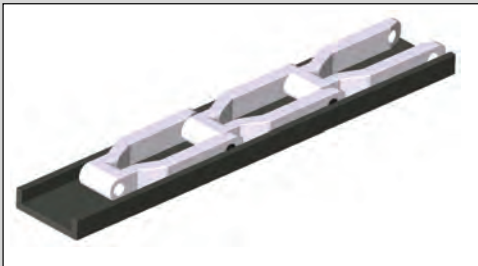

220 KSK 857

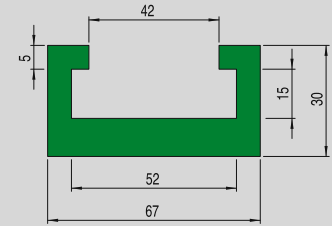

220 KSK 858

Kod	855 - 856 857 - 858
Say.	D20 - D21

Profil Bölümü/Profiles: "C"		L: Standart Uzunluk (metre)/Standart Length (meter)			Stok Kod Stock Code
Alpolen® 1000 Siyah / Black	Kullanılan Bantlar For chains	R2	Kg/m	220 KSK 857	
	857	2	0,65	220 KSK 858	
	858		0,30		

Çağrı End. A.Ş. gerekli gördüğü takdirde, teknik gelişmeler neticesinde kataloğtaki çizim ve değerler üzerinde haber vermeksizin değişiklik yapma hakkına sahiptir.

Çağrı Endüstri is reserved the right to update the technical specifications and values in this catalogue at any time without prior notice.

*Özel üretim yapılır. / On request special production is available.



YARASA BANT DÖNÜŞ ÜNİTESİ/CURVES TRACK FOR BAT CHAINS

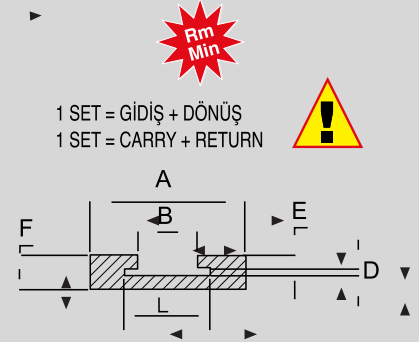
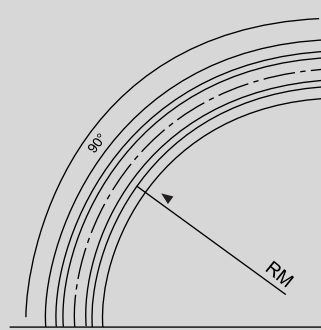

M	A	B	L	D	E	F	RM	Kg/m	Stok Kod Stock Code
Alpolen® 1000 Siyah / Black	100	43	63	5	10,5	20	250	0,160	204 112 610

YARASA BANT DÖNÜŞ ÜNİTESİ (SİLİNDİRİK KULAKLILAR İÇİN)/CURVES TRACK FOR BAT CHAINS

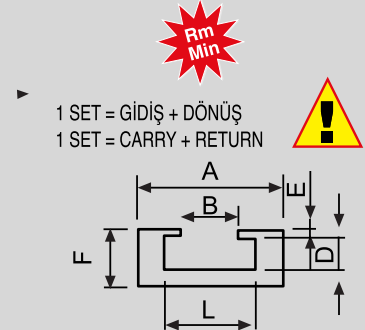
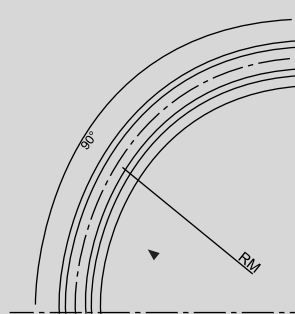
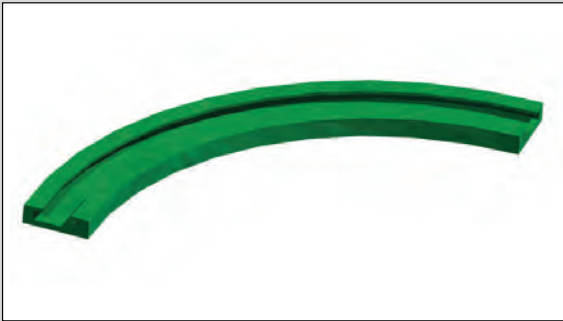

M	A	B	L	D	E	F	RM	Kg/m	Stok Kod Stock Code
Alpolen® 1000 Siyah / Black	114	49,4	79,4	18,4	5	30	250	0,170	204 114 610

ALPOLEN® 1000 90 DERECE DÖNÜŞ YATAKLARI (1873 SERİ BANTLAR İÇİN)/CURVES TRACK (FOR 1873 SERIES)

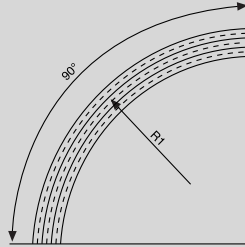

1 SET = GİDİŞ + DÖNÜŞ
1 SET = CARRY + RETURN

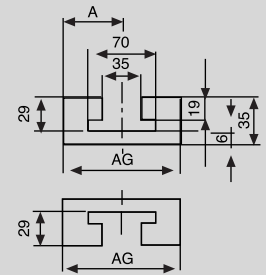

Profil Bölümü/Profiles: "C"		L= 304,8 P= 310 mm			
M	R1	A	Sıra Track	AG	Stok Kod Stock Code
Alpolen® 1000 Siyah / Black	610	82,5	50	320	221 611 873
	800		630	100	221 801 873
	610	114,3	65	320	222 611 873
	800		630	130	222 801 873
	610	190,5	100	340	223 611 873
	800		320	200	223 801 873
	610	254,0	135	630	224 611 873
	800		340	270	224 801 873
	610	304,8	160	320	220 611 873
	800		630	320	220 801 873

Çağrı End. A.Ş. gerekli gördüğü takdirde, teknik gelişmeler neticesinde katalogtaki çizim ve değerler üzerinde haber vermeksizin değişiklik yapma hakkına sahiptir.

Çağrı Endüstri is reserved the right to update the technical specifications and values in this catalogue at any time without prior notice.

*Özel üretim yapılır. / On request special production is available.



B PNÖMATİK ZİNCİR GERGİSİ/PNEUMATIC CHAIN TENSIONER

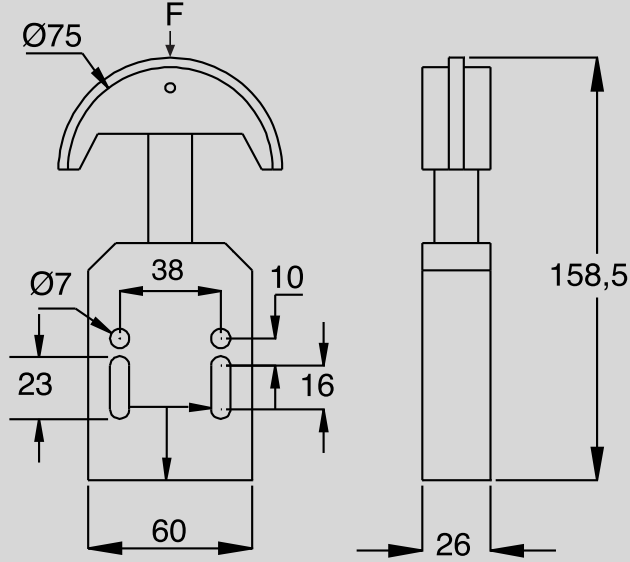

Profil Bölümü/Profiles: "C"

L: Standart Uzunluk (metre)/Standart Length (meter)

	Hatve Pitch	Profil Guide	F Baskı Kuvveti Tension Pressure (N)	Stok Kod Stock Code
ALPOLEN® 1000 Kırmızı/Red	3/8"	1	60	207 GKR 138
ALPOLEN® 1000 Kırmızı/Red	1/2"	1	60	207 GKR 112
ALPOLEN® 1000 Kırmızı/Red	5/8"	1	60	207 GKR 158
ALPOLEN® 1000 Kırmızı/Red	3/4"	1	120	207 GKR 134
ALPOLEN® 1000 Kırmızı/Red	1"	1	200	207 GKR 101
ALPOLEN® 1000 Yeşil/Green	3/8"	1	60	207 GYR 138
ALPOLEN® 1000 Yeşil/Green	1/2"	1	60	207 GYR 112
ALPOLEN® 1000 Yeşil/Green	5/8"	1	60	207 GYR 158
ALPOLEN® 1000 Yeşil/Green	3/4"	1	120	207 GYR 134
ALPOLEN® 1000 Yeşil/Green	1"	1	200	207 GYR 101

*LÜTFEN ÖZEL ÖLÇÜLERİ TALEP EDİNİZ./TO MAKE AN ORDER INDICATE DIMENSIONS.

PNÖMATİK ZİNCİR GERGİSİ/PNEUMATIC CHAIN STRETCHER

Profil Bölümü/Profiles: "C"

L: Standart Uzunluk (metre)/Standart Length (meter)

	A	Profil Guide	F Baskı Kuvveti Tension Pressure (N)	Stok Kod Stock Code
ALPOLEN® 1000 Kırmızı/Red	3/8"	2	60	207 GKR 208
ALPOLEN® 1000 Kırmızı/Red	1/2"	2	60	207 GKR 212
ALPOLEN® 1000 Kırmızı/Red	5/8"	2	60	207 GKR 258
ALPOLEN® 1000 Kırmızı/Red	3/4"	2	120	207 GKR 234
ALPOLEN® 1000 Yeşil/Green	3/8"	2	60	207 GYR 208
ALPOLEN® 1000 Yeşil/Green	1/2"	2	60	207 GYR 212
ALPOLEN® 1000 Yeşil/Green	5/8"	2	60	207 GYR 258
ALPOLEN® 1000 Yeşil/Green	3/4"	2	120	207 GYR 234

*LÜTFEN ÖZEL ÖLÇÜLERİ TALEP EDİNİZ./TO MAKE AN ORDER INDICATE DIMENSIONS.

Çağrı End. A.Ş. gerekli gördüğü takdirde, teknik gelişmeler neticesinde kataloğtaki çizim ve değerler üzerinde haber vermeksizin değişiklik yapma hakkına sahiptir.

Çağrı Endüstri is reserved the right to update the technical specifications and values in this catalogue at any time without prior notice.

*Özel üretim yapılır. / On request special production is available.



ÇAĞRI[®]
ENDÜSTRİ A.Ş.

ALHAN[®]

PROFİLLER PROFILES

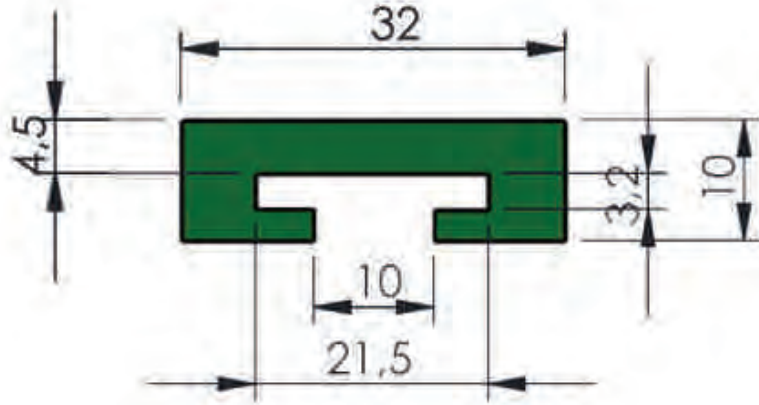

Üretimden Satış
от производства к продаже
From Production to Sales



B

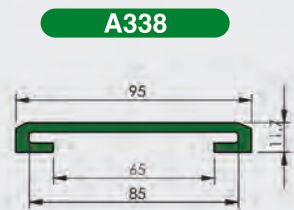
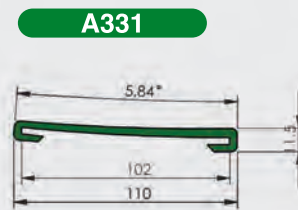
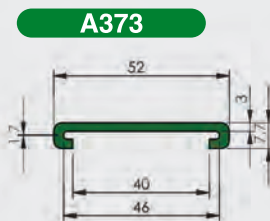
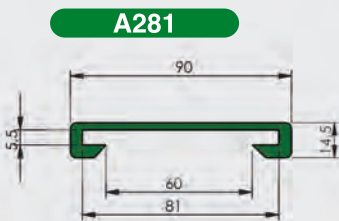
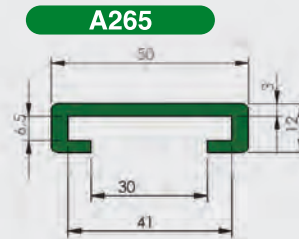
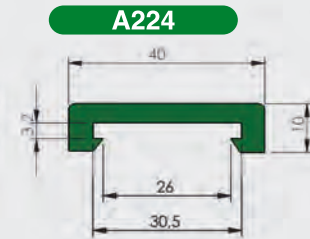
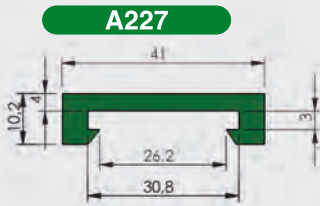
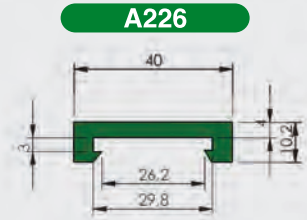
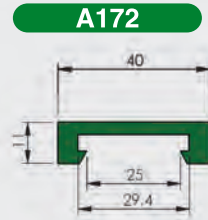
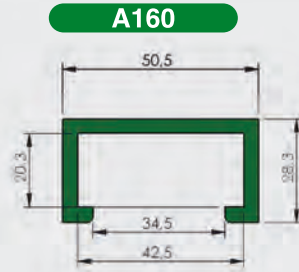
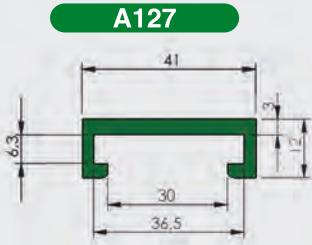
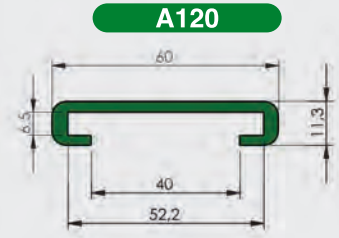
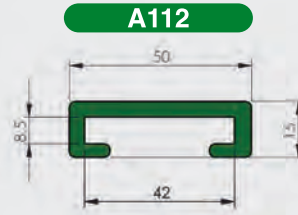
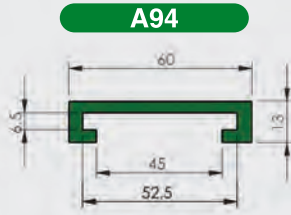
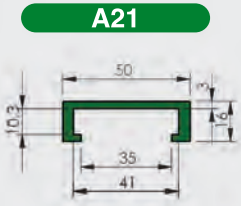
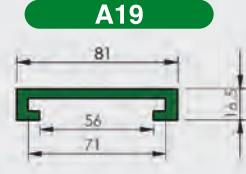
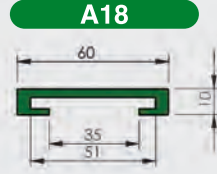
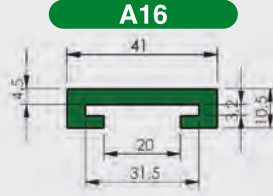
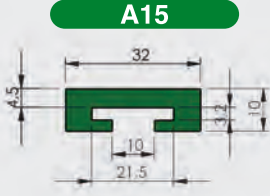

Çağrı End. A.Ş. gerekli gördüğü takdirde, teknik gelişmeler neticesinde kataloğtaki çizim ve değerler üzerinde haber vermeksizin değişiklik yapma hakkına sahiptir.

Çağrı Endüstri is reserved the right to update the technical specifications and values in this catalogue at any time without prior notice.

*Özel üretim yapılır. / On request special production is available.

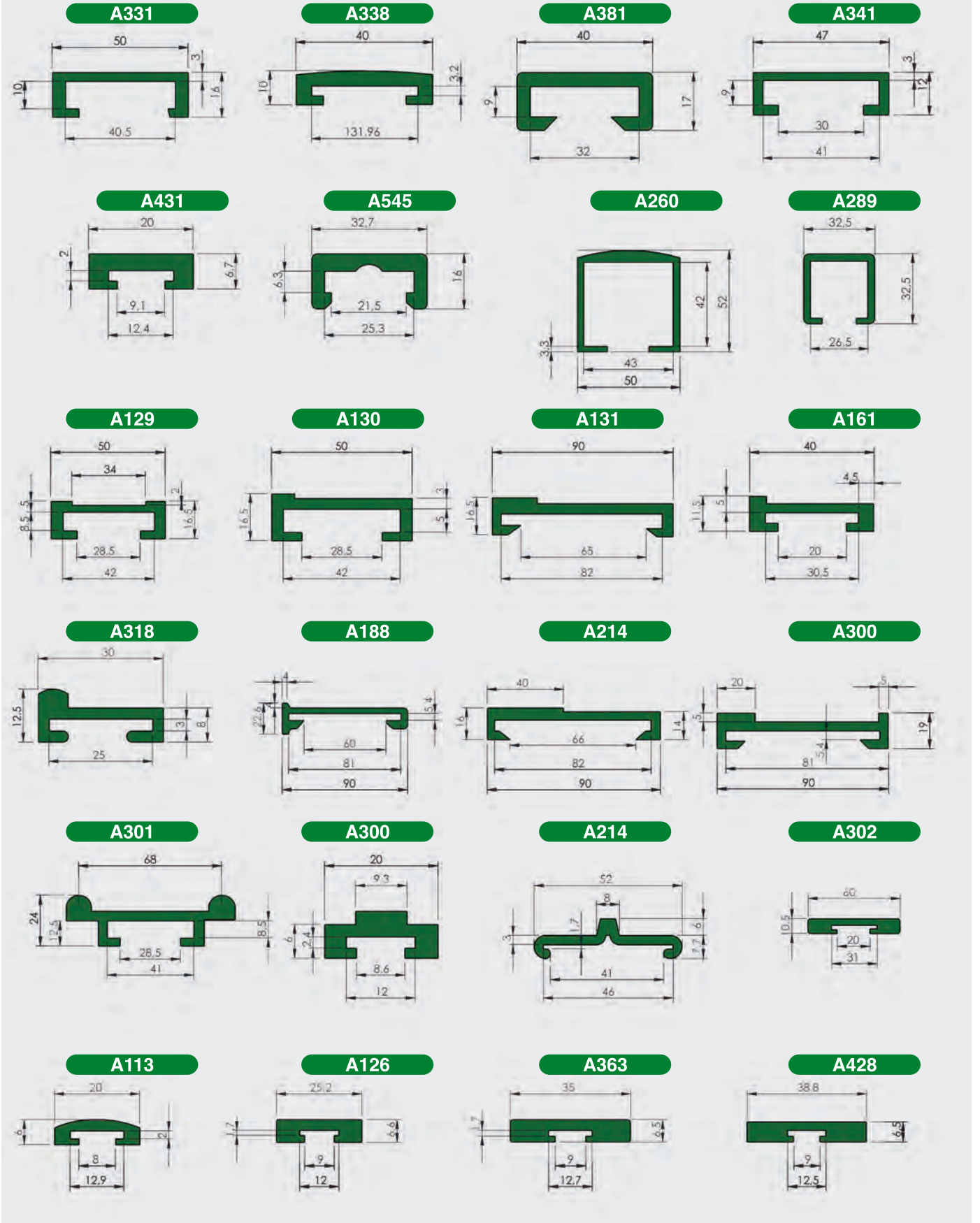

Çağrı End. A.Ş. gerekli gördüğü takdirde, teknik gelişmeler neticesinde katalogtaki çizim ve değerler üzerinde haber vermeksizin değişiklik yapma hakkına sahiptir.

Çağrı Endüstri is reserved the right to update the technical specifications and values in this catalogue at any time without prior notice.

*Özel üretim yapılır. / On request special production is available.



B

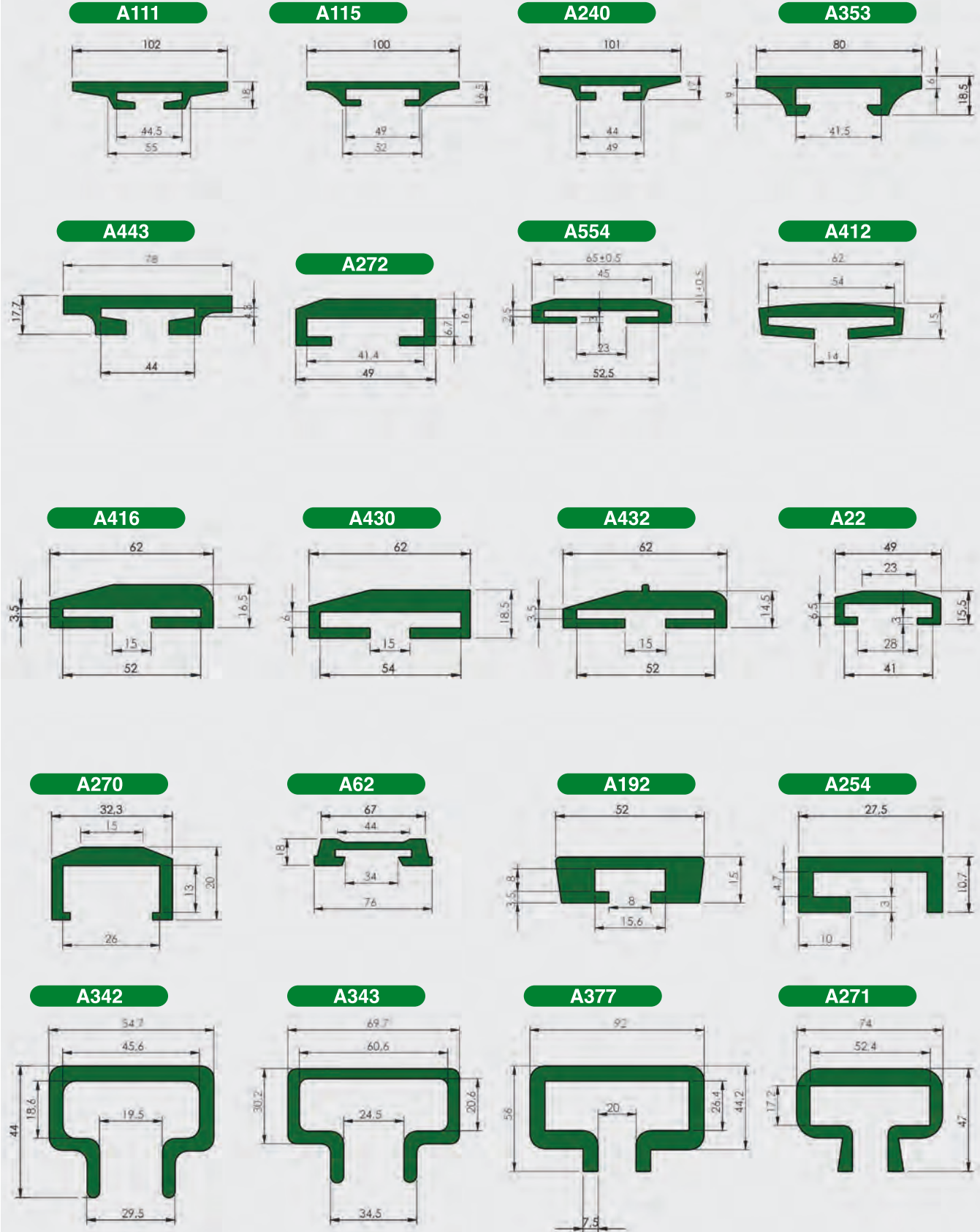

Çağrı End. A.Ş. gerekli gördüğü takdirde, teknik gelişmeler neticesinde kataloğtaki çizim ve değerler üzerinde haber vermeksizin değişiklik yapma hakkına sahiptir.

Çağrı Endüstri is reserved the right to update the technical specifications and values in this catalogue at any time without prior notice.

*Özel üretim yapılır. / On request special production is available.

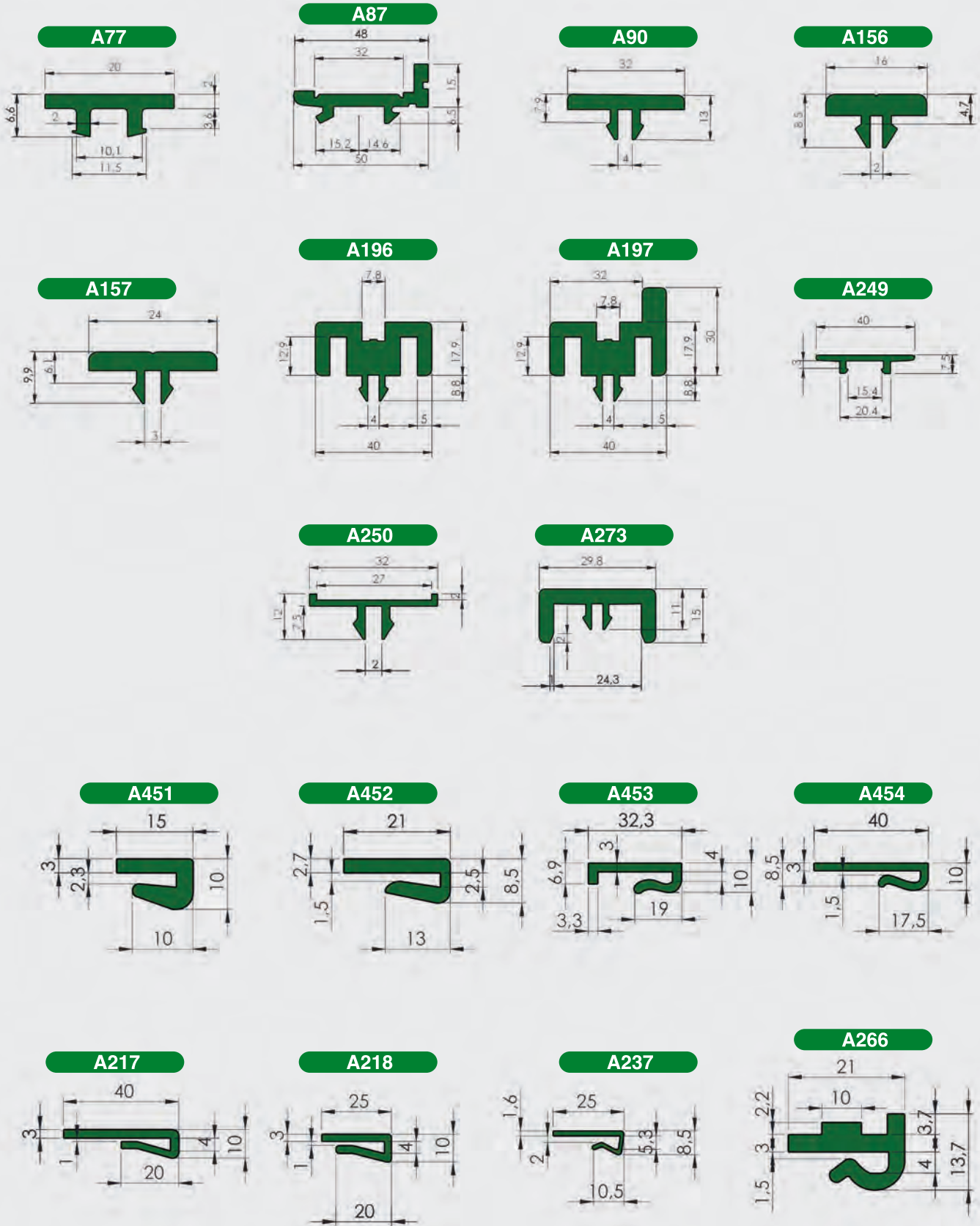

Çağrı End. A.Ş. gerekli gördüğü takdirde, teknik gelişmeler neticesinde katalogtaki çizim ve değerler üzerinde haber vermeksizin değişiklik yapma hakkına sahiptir.

Çağrı Endüstri is reserved the right to update the technical specifications and values in this catalogue at any time without prior notice.

*Özel üretim yapılır. / On request special production is available.



A10

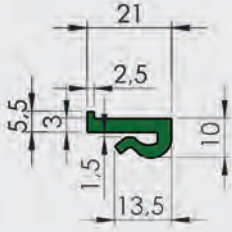

A101



A103

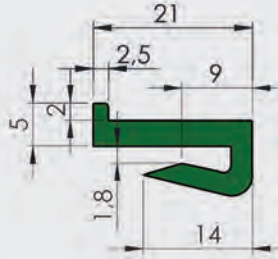

A107

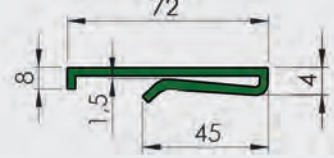

A108

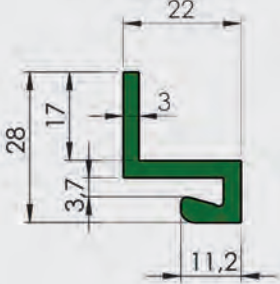

A119

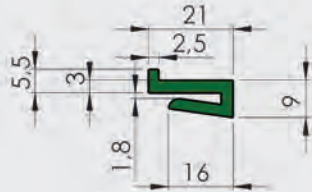

A407

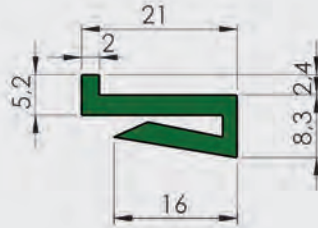

A170

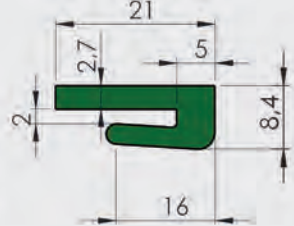

A275

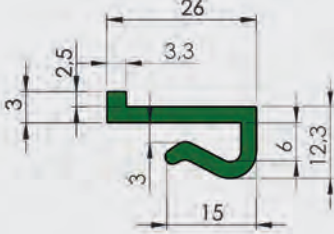

A339

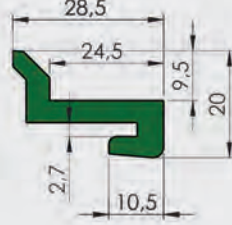

A340

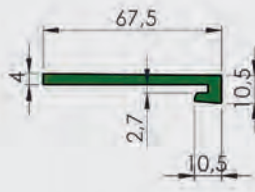

A362

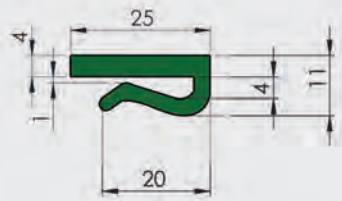

A455

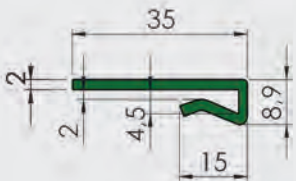

A422



A456

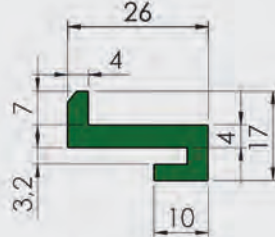

A457

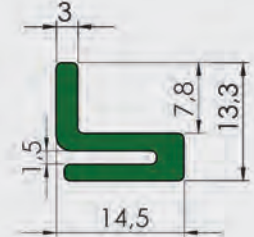

A458

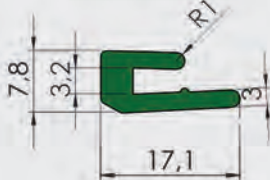

A459

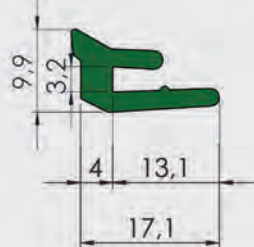

A351

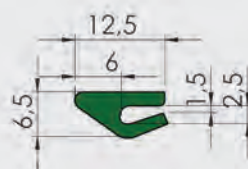

A352



Çağrı End. A.Ş. gerekli gördüğü takdirde, teknik gelişmeler neticesinde kataloğtaki çizim ve değerler üzerinde haber vermeksizin değişiklik yapma hakkına sahiptir.

Çağrı Endüstri is reserved the right to update the technical specifications and values in this catalogue at any time without prior notice.

*Özel üretim yapılır. / On request special production is available.

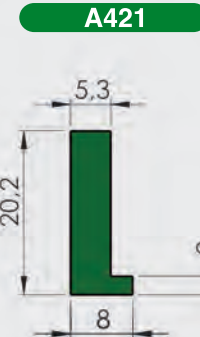
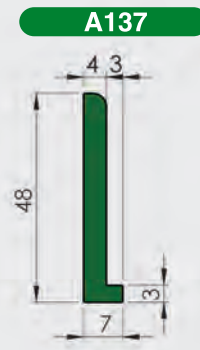
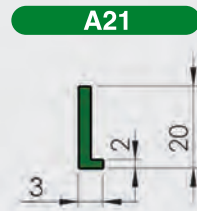
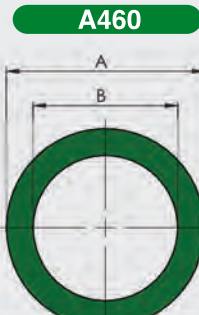
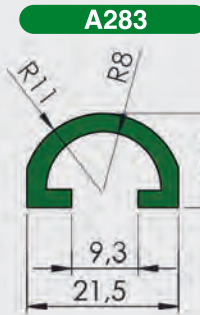
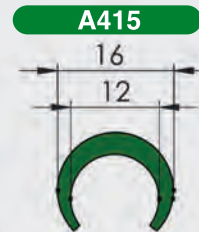
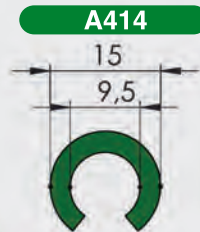
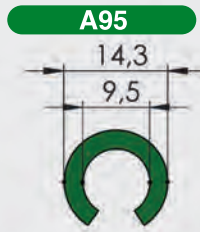
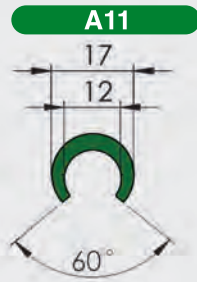
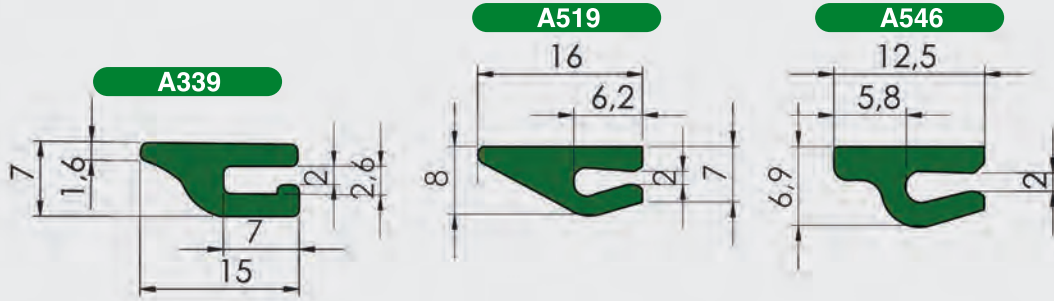

Çağrı End. A.Ş. gerekli gördüğü takdirde, teknik gelişmeler neticesinde katalogtaki çizim ve değerler üzerinde haber vermeksizin değişiklik yapma hakkına sahiptir.

Çağrı Endüstri is reserved the right to update the technical specifications and values in this catalogue at any time without prior notice.

*Özel üretim yapılır. / On request special production is available.



B

A435

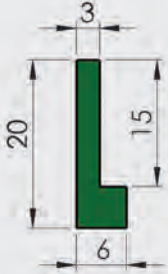

A141

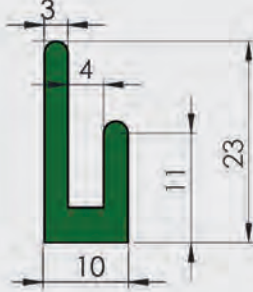

A154

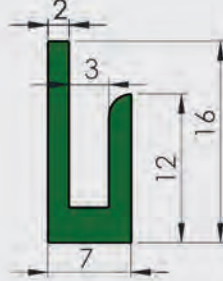

A182

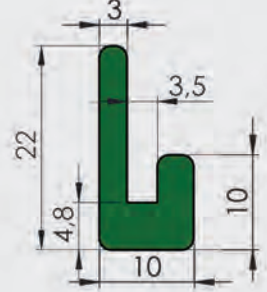

A190

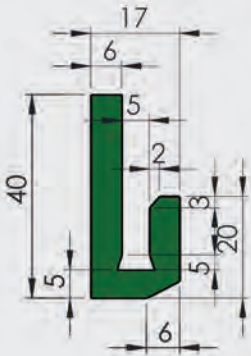

A404

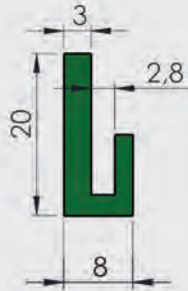

A405

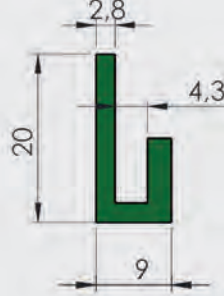

A542

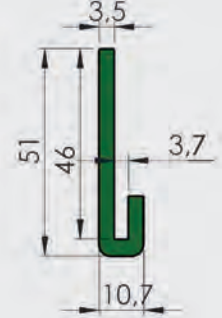

A55

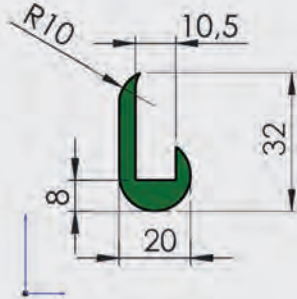

A129

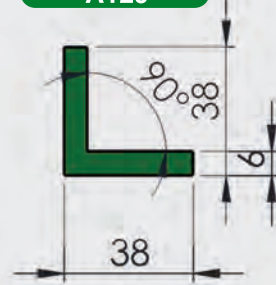

A13

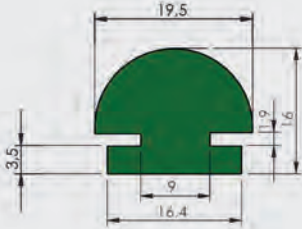

A14

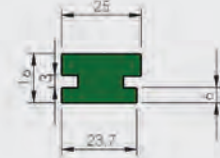

A33

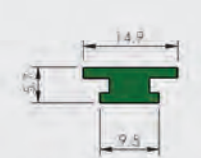

A35

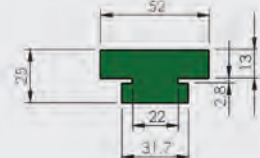

A158

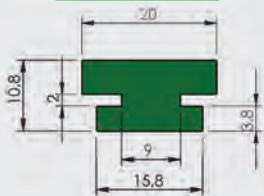

A38

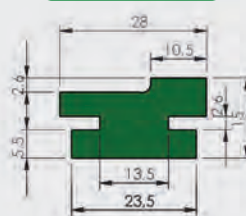

A207

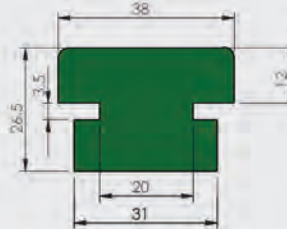

A208

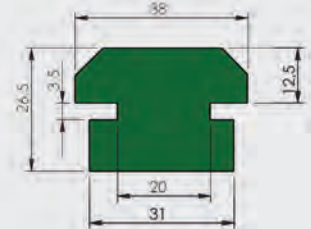

Çağrı End. A.Ş. gerekli gördüğü takdirde, teknik gelişmeler neticesinde kataloğtaki çizim ve değerler üzerinde haber vermeksizin değişiklik yapma hakkına sahiptir.

Çağrı Endüstri is reserved the right to update the technical specifications and values in this catalogue at any time without prior notice.

*Özel üretim yapılır. / On request special production is available.



A268

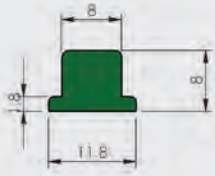

A297

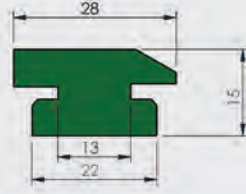

A401

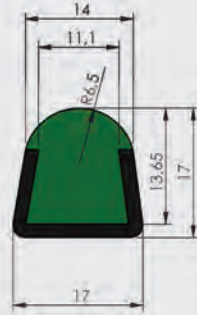

A402

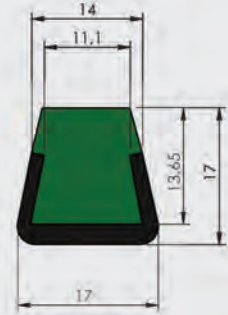

A403



A485

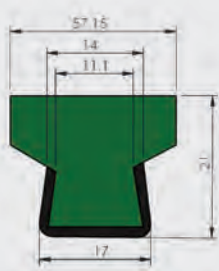

A88

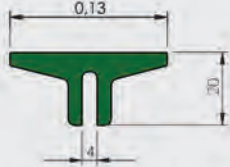

A89

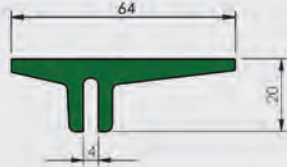

A139

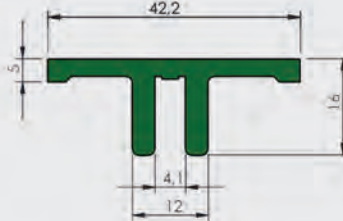

A212

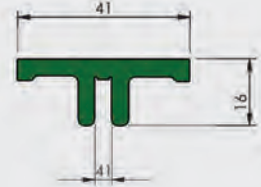

A116



A134

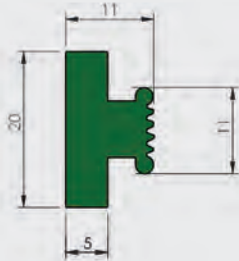

A135

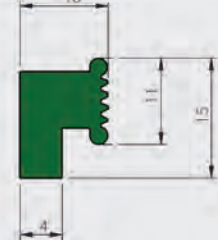

A136



A143

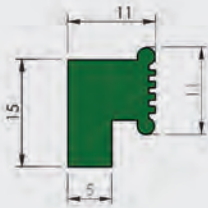

A12



A31

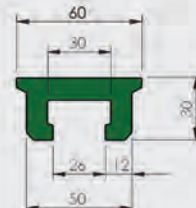

A32

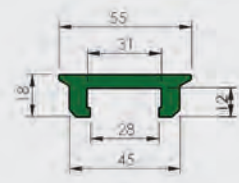

A36

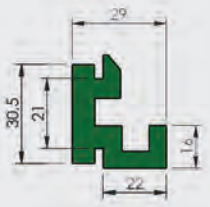

A37

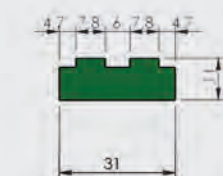

A38

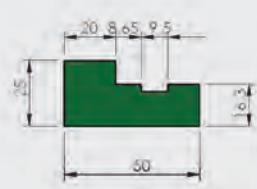

A39

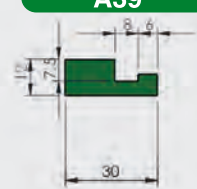

Çağrı End. A.Ş. gerekli gördüğü takdirde, teknik gelişmeler neticesinde katalogtaki çizim ve değerler üzerinde haber vermeksizin değişikliğe hakkına sahiptir.

Çağrı Endüstri is reserved the right to update the technical specifications and values in this catalogue at any time without prior notice.

*Özel üretim yapılır. / On request special production is available.



B

A46

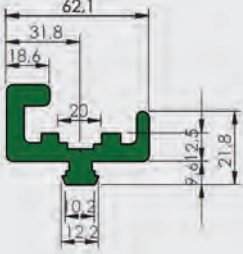

A48

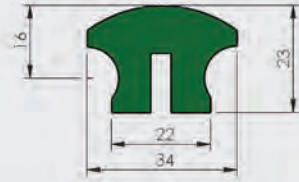

A365

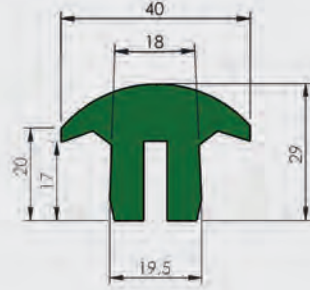

A461

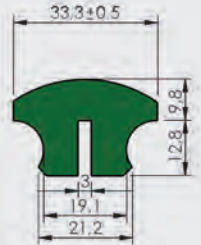

A49

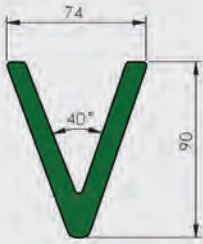

A53



A56

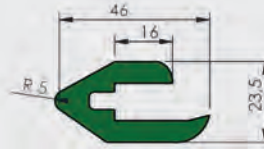

A58

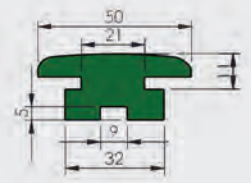

A65

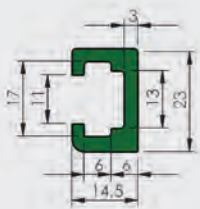

A66

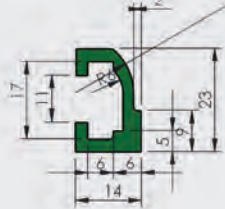

A67

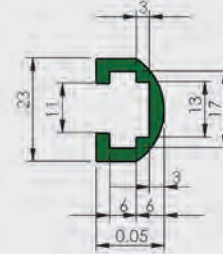

A80

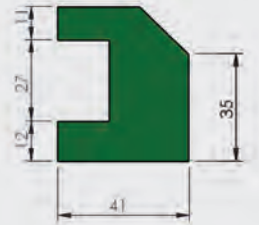

A81

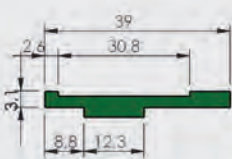

A82

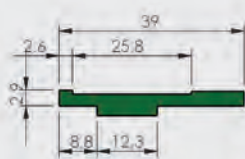

A85

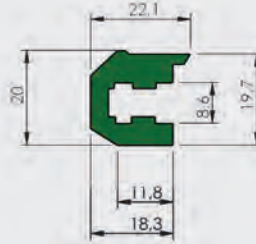

A86

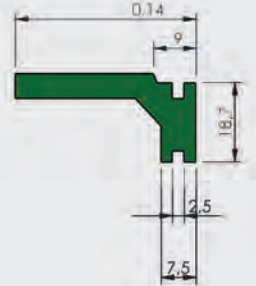

A91

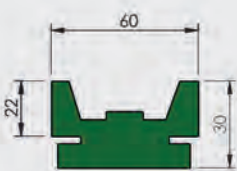

A92

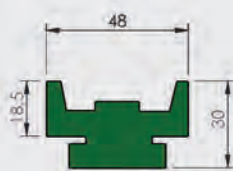

A93

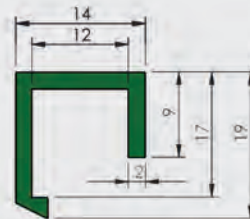

A96

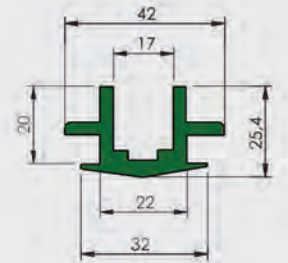

Çağrı End. A.Ş. gerekli gördüğü takdirde, teknik gelişmeler neticesinde kataloğtaki çizim ve değerler üzerinde haber vermeksizin değişiklik yapma hakkına sahiptir.

Çağrı Endüstri is reserved the right to update the technical specifications and values in this catalogue at any time without prior notice.

*Özel üretim yapılır. / On request special production is available.



A99

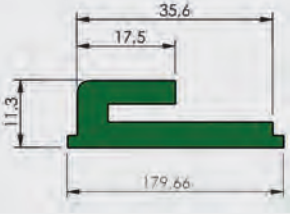

A100

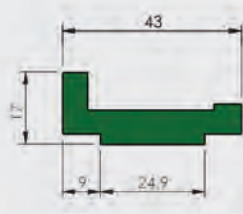

A104

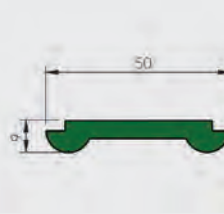

A105

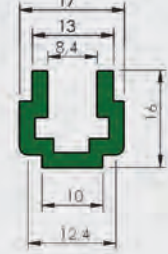

A106

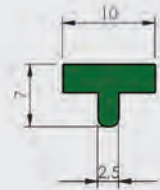

A110

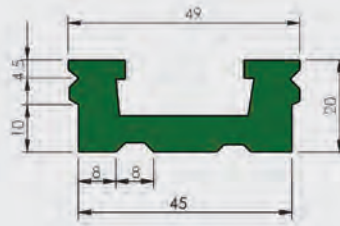

A121

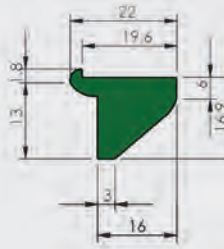

A122

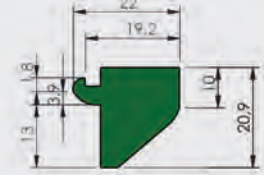

A144

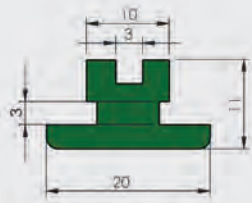

A153

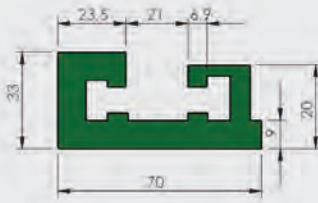

A162



A166

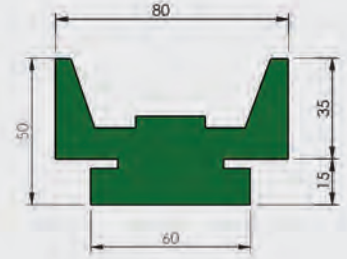

A168

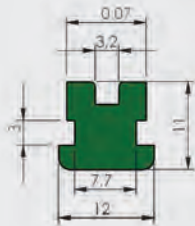

A171

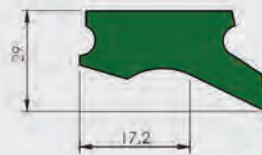

A174



A175

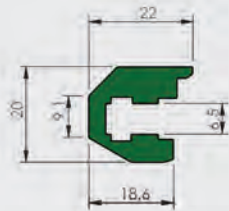

A177



A178

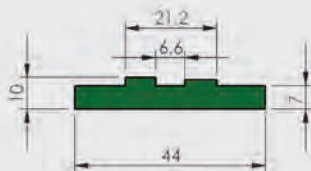

A179

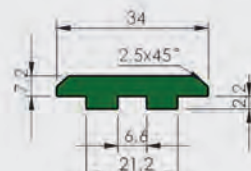

A181

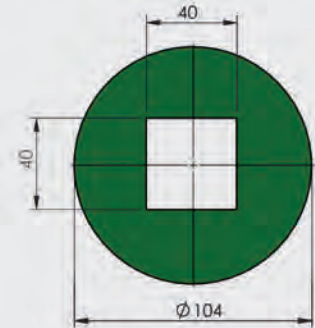

Çağrı End. A.Ş. gerekli gördüğü takdirde, teknik gelişmeler neticesinde katalogtaki çizim ve değerler üzerinde haber vermeksizin değişiklik yapma hakkına sahiptir.

Çağrı Endüstri is reserved the right to update the technical specifications and values in this catalogue at any time without prior notice.

*Özel üretim yapılır. / On request special production is available.



B

A185

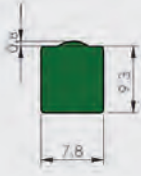

A189

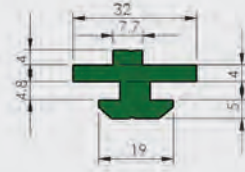

A193

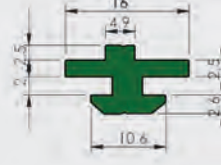

A194

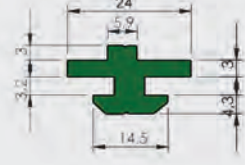

A195

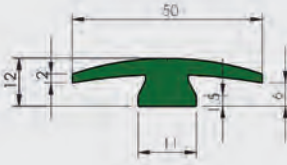

A198

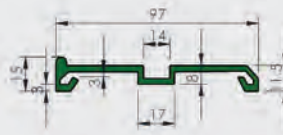

A199

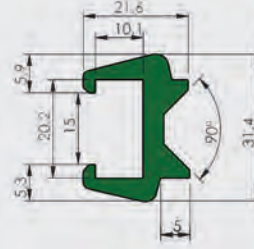

A201

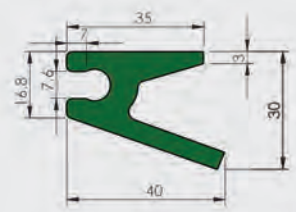

A202

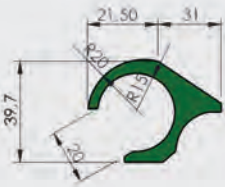

A204



A215

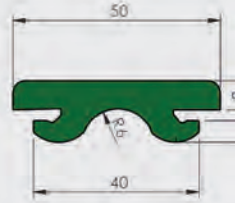

A.....

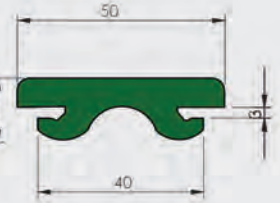

A224



A225

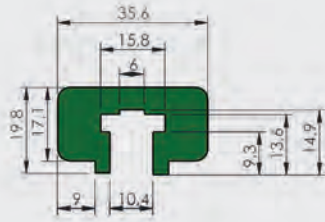

A230

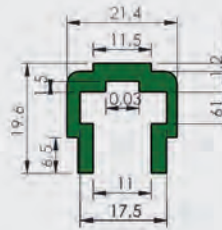

A232

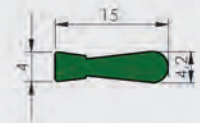

A233



A238

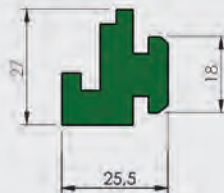

A242



A251

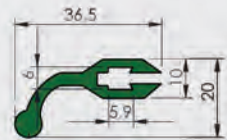

Çağrı End. A.Ş. gerekli gördüğü takdirde, teknik gelişmeler neticesinde kataloğtaki çizim ve değerler üzerinde haber vermeksizin değişiklik yapma hakkına sahiptir.

Çağrı Endüstri is reserved the right to update the technical specifications and values in this catalogue at any time without prior notice.

*Özel üretim yapılır. / On request special production is available.



A252

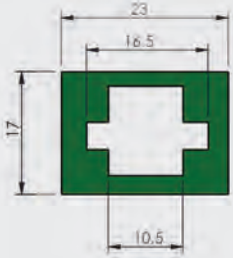

A253

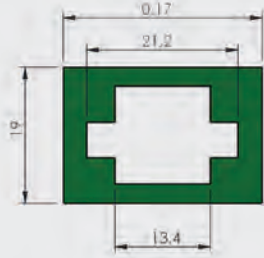

A258

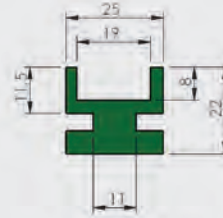

A259

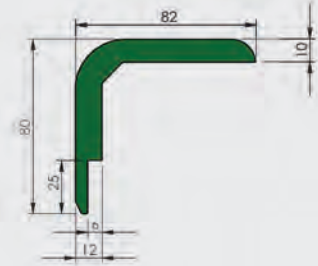

A261

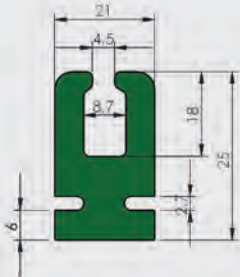

A335

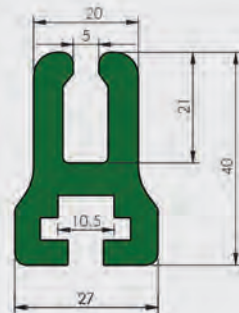

A330

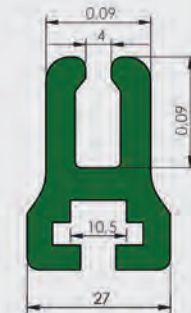

A384

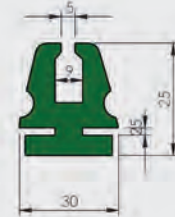

A391



A516

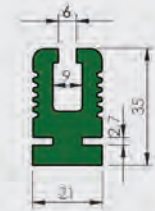

A262

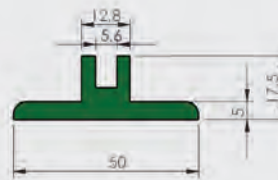

A263

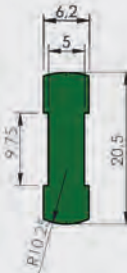

A274

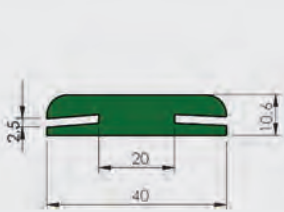

A277

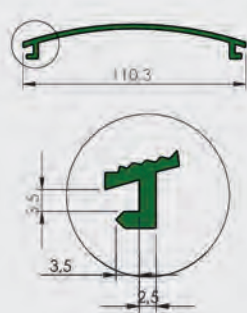

A551

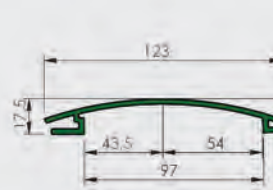

A278

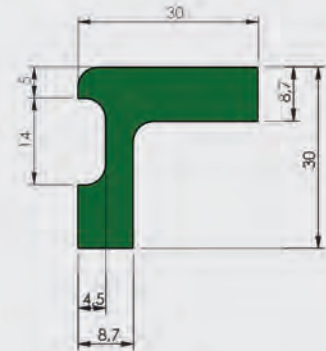

A279

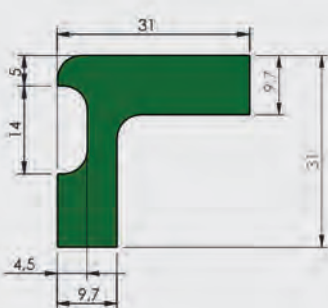

A280

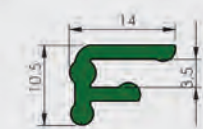

A282

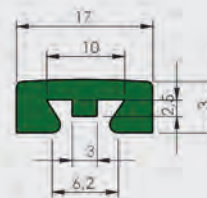

A284

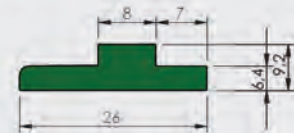

Çağrı End. A.Ş. gerekli gördüğü takdirde, teknik gelişmeler neticesinde kataloğtaki çizim ve değerler üzerinde haber vermeksizin değişiklik yapma hakkına sahiptir.

Çağrı Endüstri is reserved the right to update the technical specifications and values in this catalogue at any time without prior notice.

*Özel üretim yapılır. / On request special production is available.



B

A285

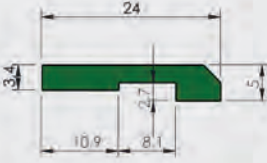

A287

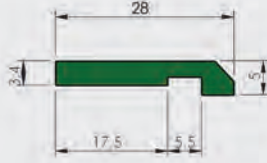

A286

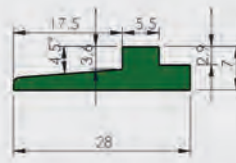

A294

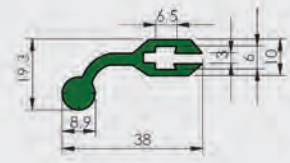

A462

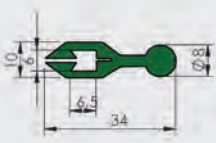

A302

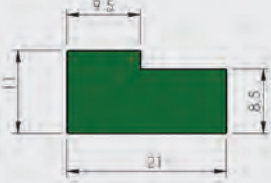

A303

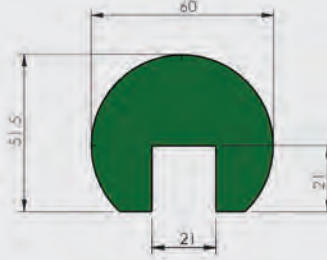

A330

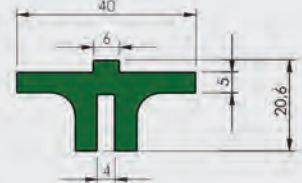

A463

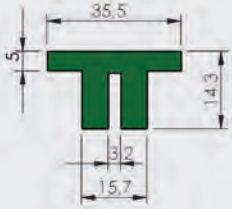

A311

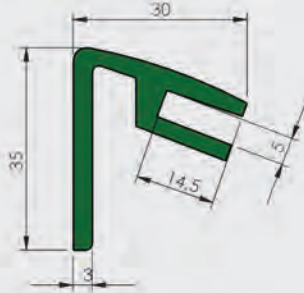

A313



A330

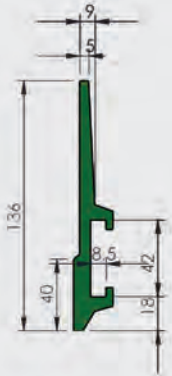

A464

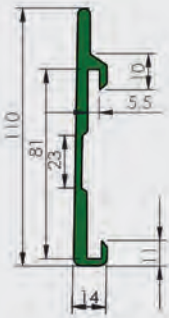

A315

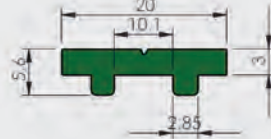

A398

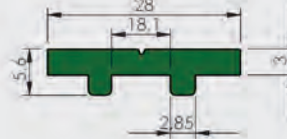

A317

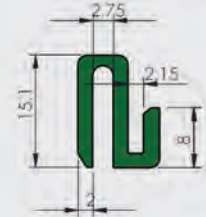

A318



A319

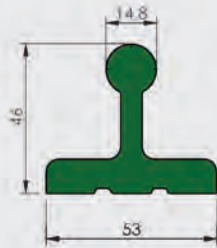

A320

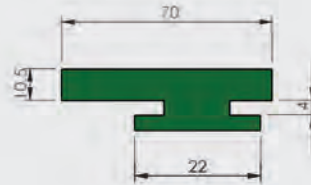

A321

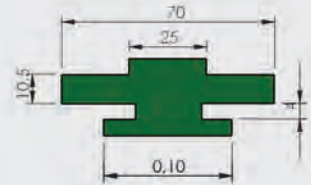

Çağrı End. A.Ş. gerekli gördüğü takdirde, teknik gelişmeler neticesinde kataloğtaki çizim ve değerler üzerinde haber vermeksizin değişiklik yapma hakkına sahiptir.

Çağrı Endüstri is reserved the right to update the technical specifications and values in this catalogue at any time without prior notice.

*Özel üretim yapılır. / On request special production is available.



A322

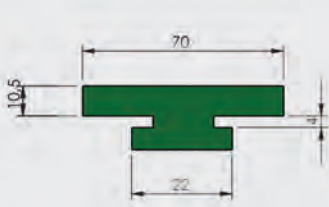

A323

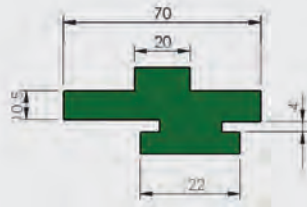

A324

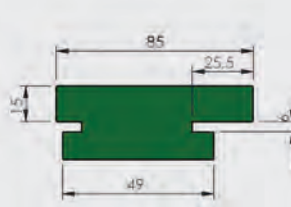

A325

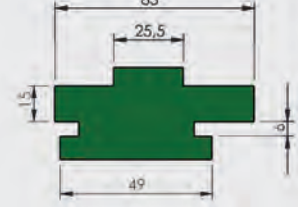

A326

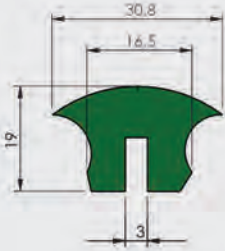

A327

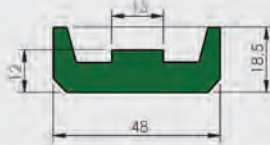

A334

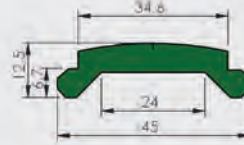

A409

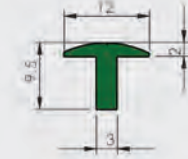

A410

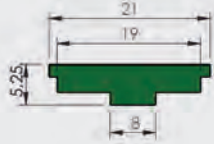

A442

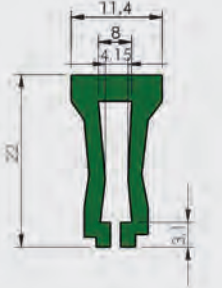

A332



A337

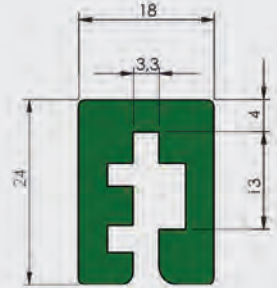

A560

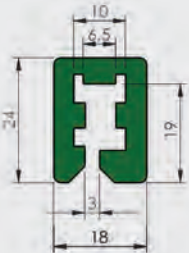

A50



A54

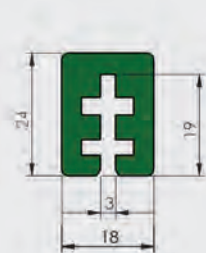

A350

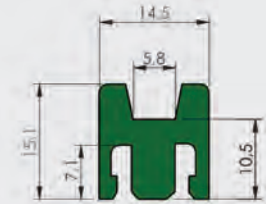

A354

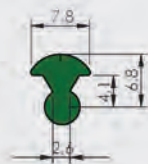

A355

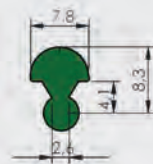

A356

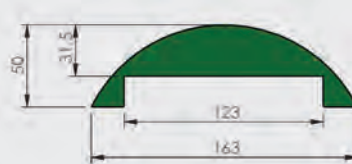

A357

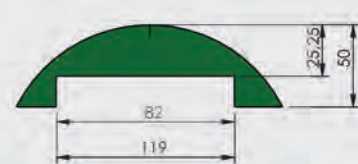

Çağrı End. A.Ş. gerekli gördüğü takdirde, teknik gelişmeler neticesinde kataloğtaki çizim ve değerler üzerinde haber vermeksizin değişiklik yapma hakkına sahiptir.

Çağrı Endüstri is reserved the right to update the technical specifications and values in this catalogue at any time without prior notice.

*Özel üretim yapılır. / On request special production is available.



B

A360

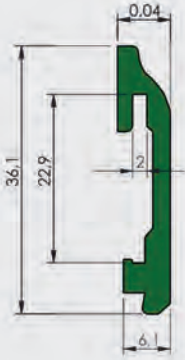

A361

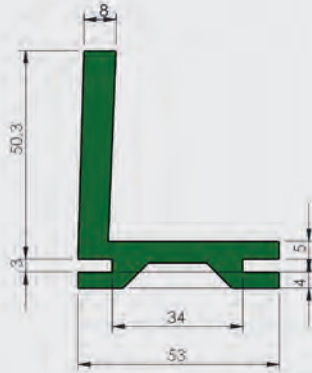

A364

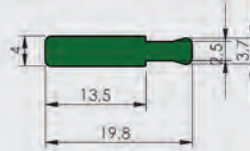

A370

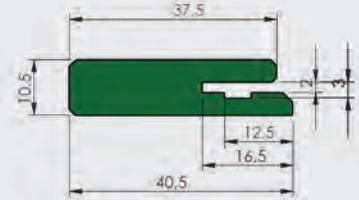

A380

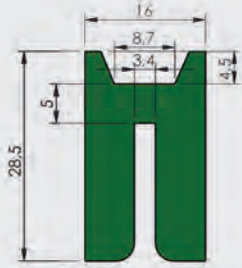

A385



A388

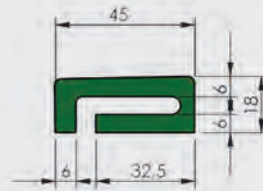

A389

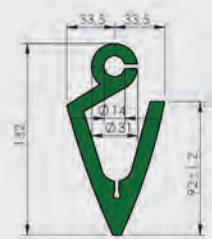

A465

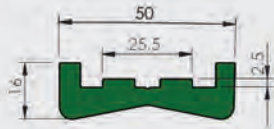

A466

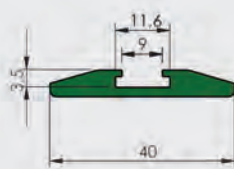

A467

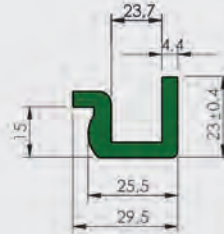

A468

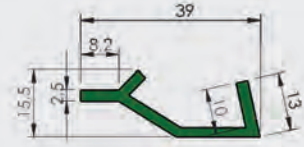

A521

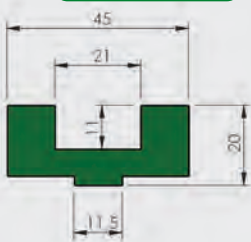

A522

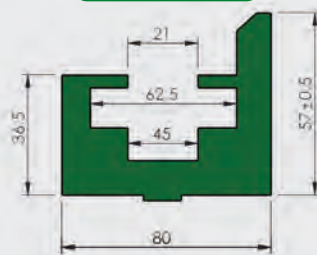

A528

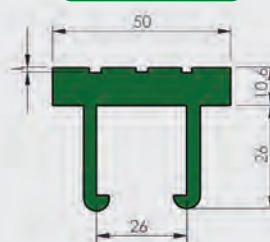

A531

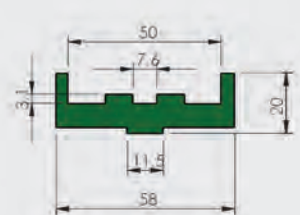

A532

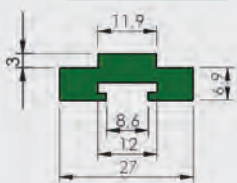

A537

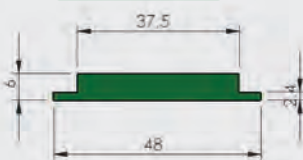

A540

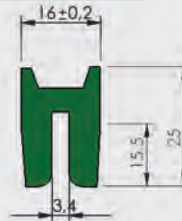

A543

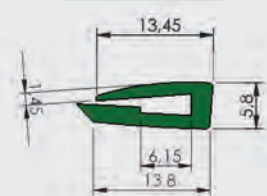

Çağrı End. A.Ş. gerekli gördüğü takdirde, teknik gelişmeler neticesinde kataloğtaki çizim ve değerler üzerinde haber vermeksizin değişiklik yapma hakkına sahiptir.

Çağrı Endüstri is reserved the right to update the technical specifications and values in this catalogue at any time without prior notice.

*Özel üretim yapılır. / On request special production is available.

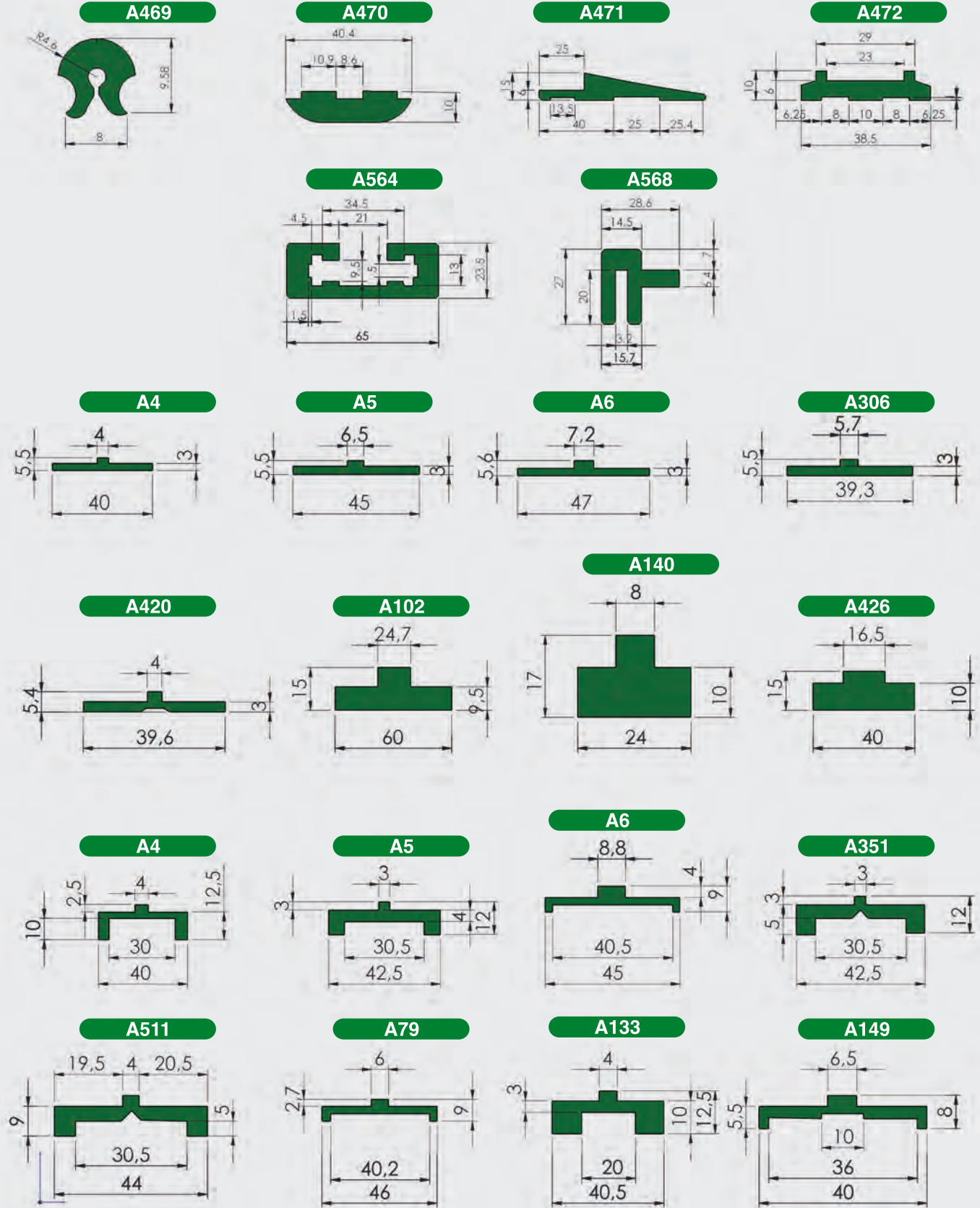

Çağrı End. A.Ş. gerekli gördüğü takdirde, teknik gelişmeler neticesinde katalogtaki çizim ve değerler üzerinde haber vermeksizin değişiklik yapma hakkına sahiptir.

Çağrı Endüstri is reserved the right to update the technical specifications and values in this catalogue at any time without prior notice.

*Özel üretim yapılır. / On request special production is available.



B

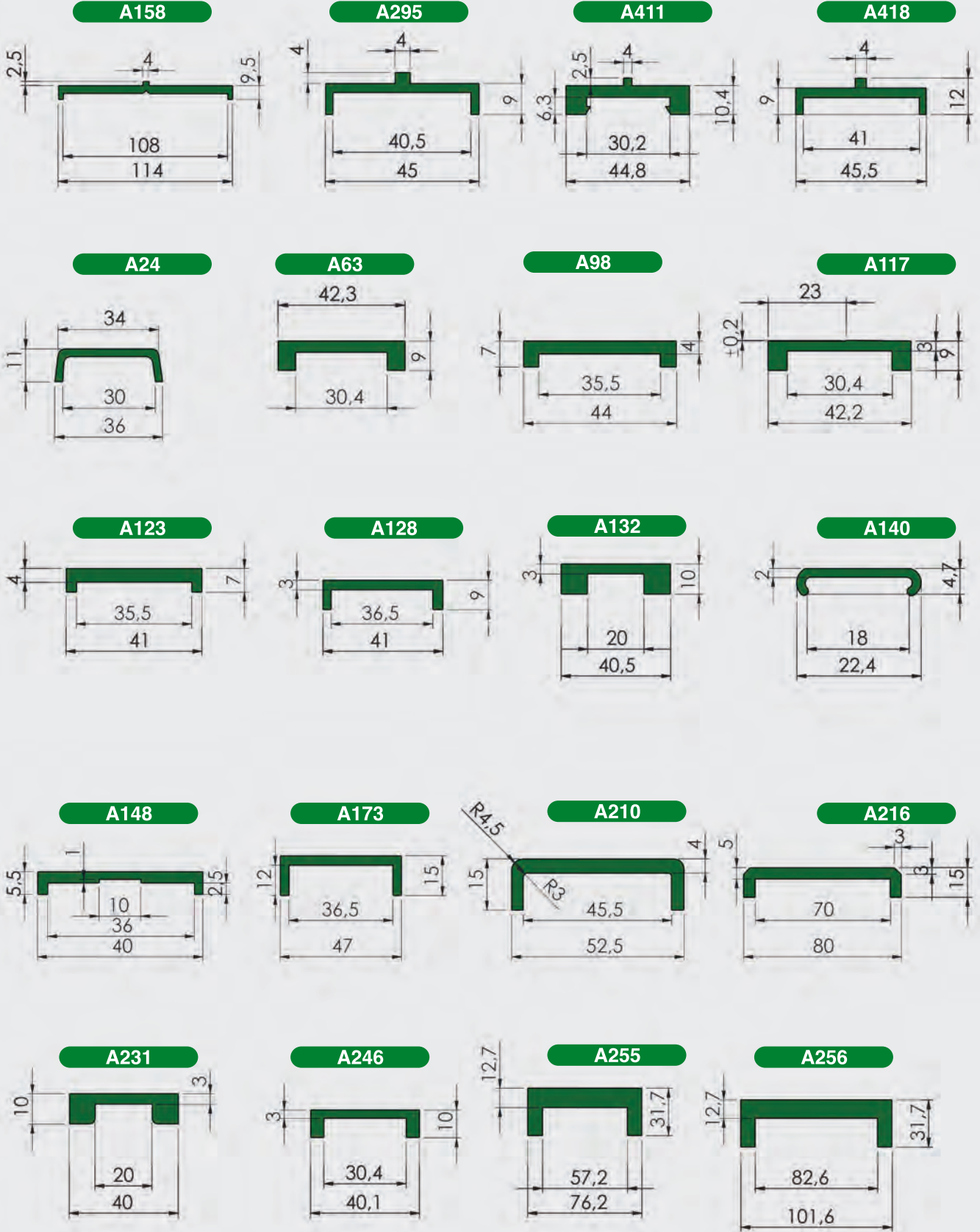

Çağrı End. A.Ş. gerekli gördüğü takdirde, teknik gelişmeler neticesinde kataloğtaki çizim ve değerler üzerinde haber vermeksizin değişiklik yapma hakkına sahiptir.

Çağrı Endüstri is reserved the right to update the technical specifications and values in this catalogue at any time without prior notice.

*Özel üretim yapılır. / On request special production is available.



A269

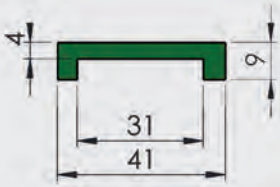

A296

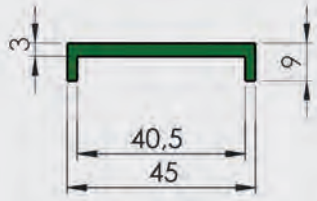

A344



A408

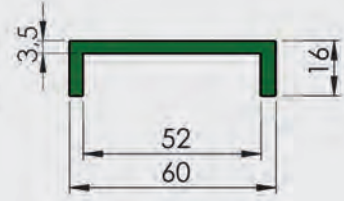

A473



A474



A475



A441



A23

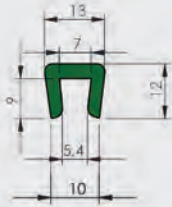

A219

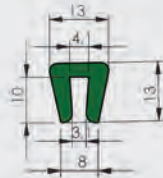

A220



A221

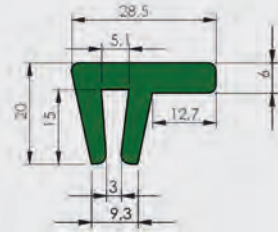

A235

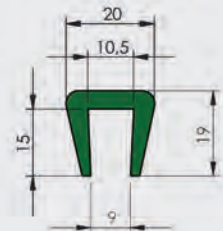

A236

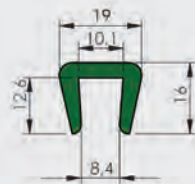

A241

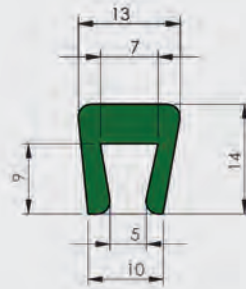

A372

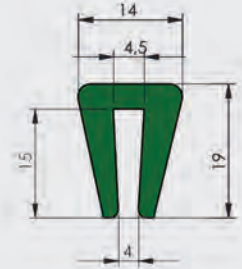

A413

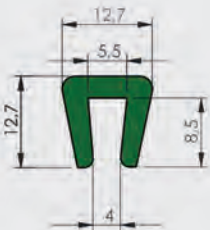

A417

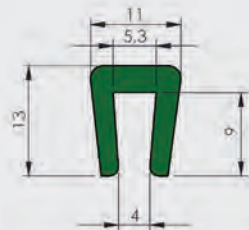

A427

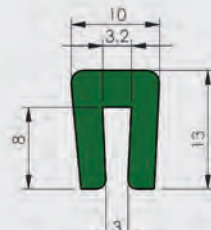

A167

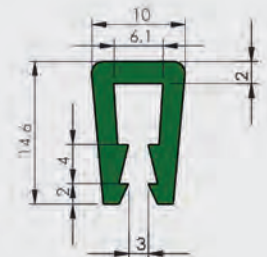

Çağrı End. A.Ş. gerekli gördüğü takdirde, teknik gelişmeler neticesinde katalogtaki çizim ve değerler üzerinde haber vermeksizin değişiklik yapma hakkına sahiptir.

Çağrı Endüstri is reserved the right to update the technical specifications and values in this catalogue at any time without prior notice.

*Özel üretim yapılır. / On request special production is available.



B

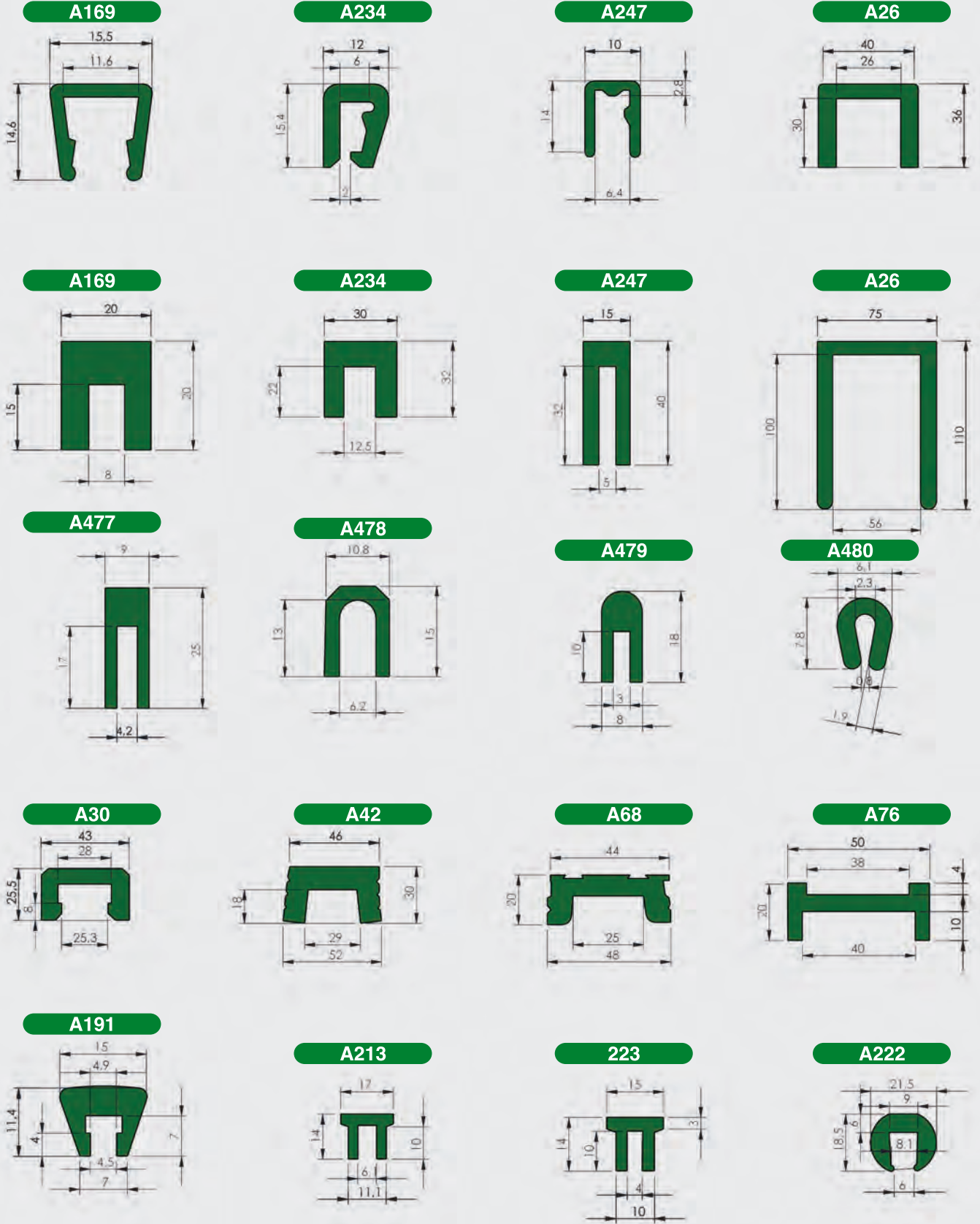

Çağrı End. A.Ş. gerekli gördüğü takdirde, teknik gelişmeler neticesinde kataloğtaki çizim ve değerler üzerinde haber vermeksizin değişiklik yapma hakkına sahiptir.

Çağrı Endüstri is reserved the right to update the technical specifications and values in this catalogue at any time without prior notice.

*Özel üretim yapılır. / On request special production is available.



A500

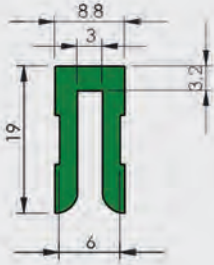

A364

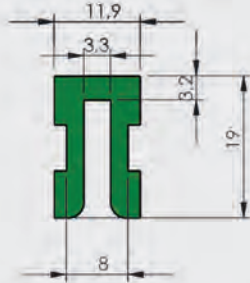

A288

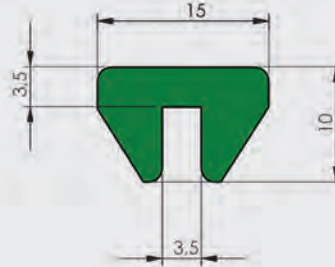

A229

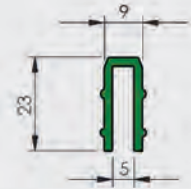

A7

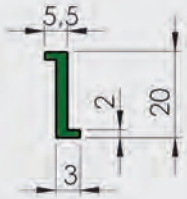

A8



A9

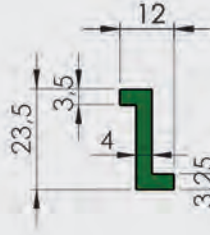

A124

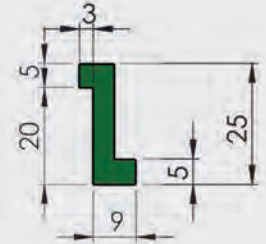

A152

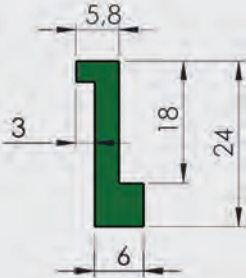

A187



A205

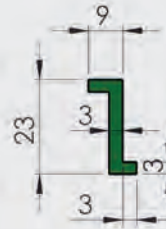

A211



A293

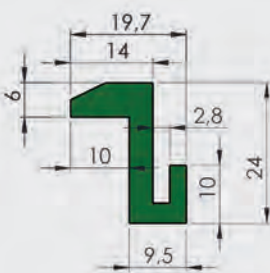

A310

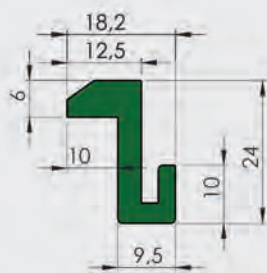

A406

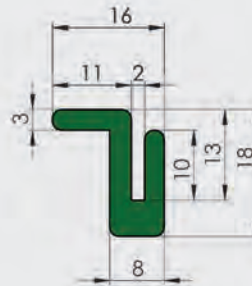

A424



A310

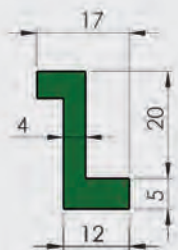

A406



A424



A436

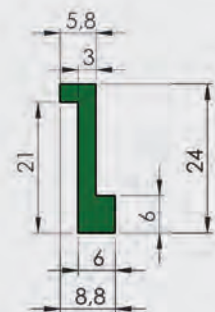

Çağrı End. A.Ş. gerekli gördüğü takdirde, teknik gelişmeler neticesinde katalogtaki çizim ve değerler üzerinde haber vermeksizin değişiklik yapma hakkına sahiptir.

Çağrı Endüstri is reserved the right to update the technical specifications and values in this catalogue at any time without prior notice.

*Özel üretim yapılır. / On request special production is available.



B UYGULAMALAR/APPLICATIONS

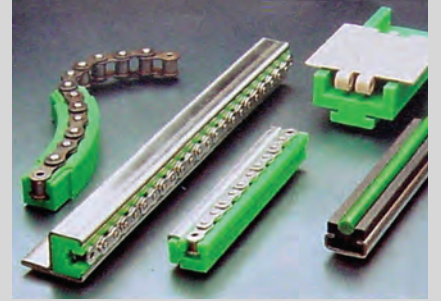
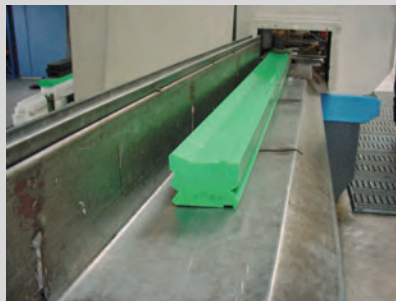
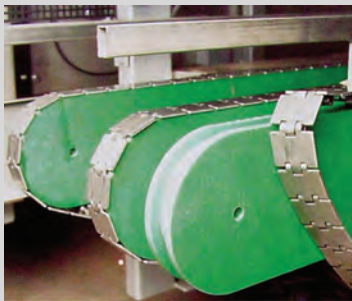
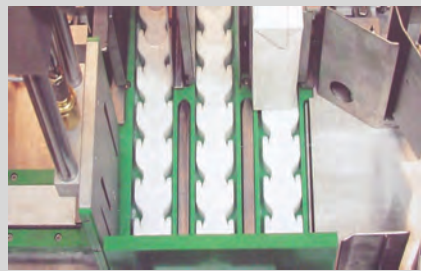
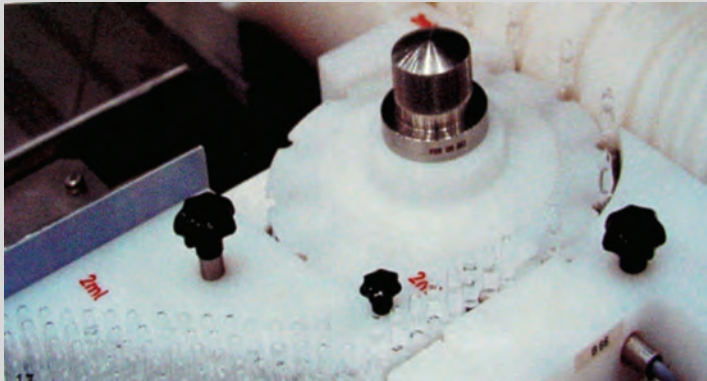
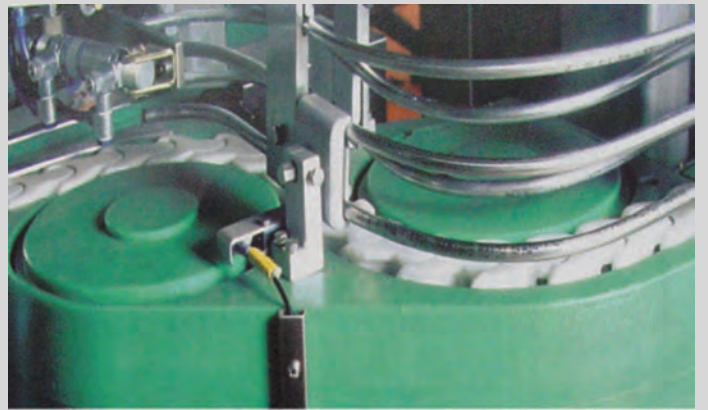
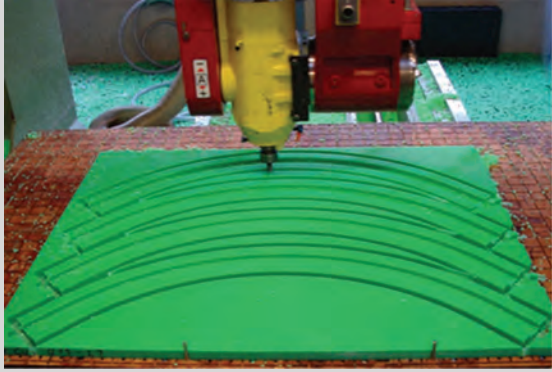

Çağrı End. A.Ş. gerekli gördüğü takdirde, teknik gelişmeler neticesinde kataloğtaki çizim ve değerler üzerinde haber vermeksizin değişiklik yapma hakkına sahiptir.

Çağrı Endüstri is reserved the right to update the technical specifications and values in this catalogue at any time without prior notice.

*Özel üretim yapılır. / On request special production is available.



Kimyasal Dirençler Chemical Resistance Temperatures up to 65°C 65°C'ye Kadar	Polyamid Polyamide	Çelik Steel	Paslanmaz Çelik Stainless Steel AISI 304	Paslanmaz Çelik Stainless Steel AISI 430	Düşük Sürtümlü Asetal LF Acetal (POM)	ALPOLEN® 1000 UHMW	Polipropilen Polypropylene (PP)
Aseton Acetone	+	-	+	+	+	+	+
Asedik Asit Acetic Acid (max.5%)	-	-	+	-	-	+	+
Sitrik Asit Citric Acid	0	-	+	0	0	+	0
Formik Asit Formic Acid	-	+	+	+	-	+	+
Fosforik Asit Phosphoric Acid (max.10%)	-	-	+	-	-	+	+
Hidroklorik Asit Hydrochloric Acid (max.2%)	-	-	-	-	-	+	+
Laktik Asit Lactic Acid	+	-	+	-	+	+	+
Nitrik Asit Nitric Acid	-	-	+	0	-	0	+
Sülfit Asit Sulphide Acid	-	-	-	-	-	-	+
Yağ Oil (vegetable or mineral)	+	+	0	+	+	+	+
Sabun Soap and water	+	0	+	+	+	+	+
Tatlı Su Fresh water	+	-	+	+	+	+	+
Deniz Suyu Sea water	-	0	+	0	+	+	+
Alkol Alcohol	+	+	+	+	+	+	+
Amonyak Ammonia	+	0	+	+	-	+	+
Alkolsüz İçki Soft drinks	+	+	+	+	+	+	+
İspirto Spirits	+	+	+	+	+	+	+
Benzen Benzene	+	+	+	+	+	0	-
Benzol Benzol	+	+	+	+	+	+	0
Bira Beer	+	+	+	+	+	+	+
Çikolata Chocolate	0	+	+	+	0	0	+
Sodyum Hidroklorid Sodium Hydrochloride	+	-	0	-	+	+	+
Petrol Petrol	+	+	+	+	+	0	+

B

Kımyasal Dirençler Chemical Resistance Temperatures up to 65°C 65°C'ye Kadar	Polyamid Polyamide	Çelik Steel	Paslanmaz Çelik Stainless Steel AISI 304	Paslanmaz Çelik Stainless Steel AISI 430	Düşük Sürtümlü Asetal LF Acetal (POM)	ALPOLLEN® 1000 UHMW	Polipropilen Polypropylene (PP)
Sodyum Hidroksid Sodium hydroxide (max.25%)	+	-	+	+	-	+	+
Sodyum Hipoklorid Sodium hypochlorite	+	-	-	-	-	+	+
Meyve Suyu Fruit Juices	+	-	+	0	+	+	+
Sebze Suyu Juices vegetable	+	0	+	+	+	+	+
Süt Milk	+	+	+	+	+	+	+
Hardal Mustard	0	+	+	+	+	0	+
Parafin Paraffin	+	+	+	+	+	+	0
Hidrojen Peroksit Hydrogen peroxide	-	-	+	0	-	0	+
Karbon Tetraklorid Carbon tetrachloride	+	0	0	0	+	0	-
Toluene	-	-	-	-	+	0	+
Turpentin Turpentine	-	+	+	+	-	0	+
Sirke Vinegar	+	-	0	-	+	+	+
Şarap Wine	+	+	+	+	+	+	+
Viski Whisky	+	+	+	+	+	+	+
Lodine	-	0	0	0	0	0	0
Xilol	-	-	-	-	-	-	-

+ = İyi / Good

0 = Orta / Average

- = Yetersiz / Unsatisfactory

Yukarıda belirtilen değerler firma tecrübesine dayalı olup garanti niteliği taşımamaktadır.

Malzemeler ve ürünler çalışma şartları doğrultusunda test edilerek uygun koşullar saptanmalıdır.

Ürünlerimizin Mekanik Analizleri Pro-Engineer Wildfire Programında yapılmaktadır.

This information may be considered as a basis for recommendation, but not as a guarantee.

Materials and products should be tested under exact intended service conditions

to determine their suitability for a particular purpose.

Mechanical Analysis of products on  Pro-Engineer Wildfire Software.



Gültekinöğlü
Şirketler Öbeği / Corporation



ÇAĞRI
ENDÜSTRİ A.Ş.

ALHAN

MARKASIYLA ÜRETİM YAPMAKTADIR/TRADE MARK
www.alhan-cagri.com info@alhan-cagri.com

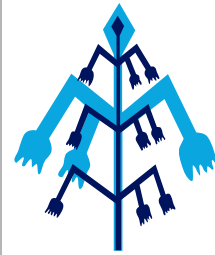
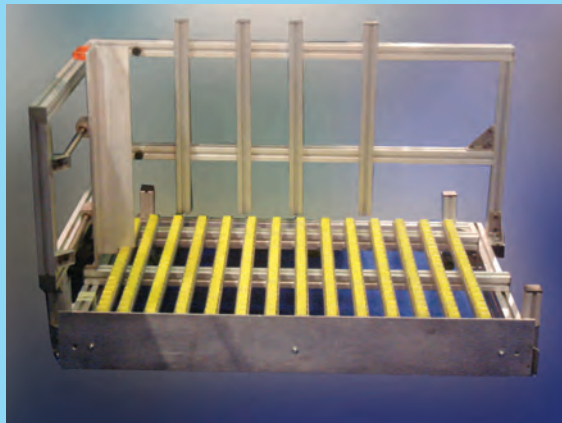

SATUK
BUĞRAHAN
MAKİNE
LTD. ŞTİ.

www.satukbugrahan.com
info@satukbugrahan.com
www.konveyorsistemleri.com

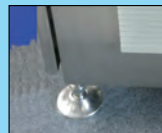

www.dinamikraflama.com



Bu katalog teknik bilgiler içeren bir dökümandır. Hiçbir surette ticari olarak kullanılmaz.
T.C.'nin ilgili yasalarının dolaylı kanuni hakkımız saklıdır!
This catalogue includes technical information. It will never be used for trading purpose.
As a result of T.C. laws, our justice is secret!

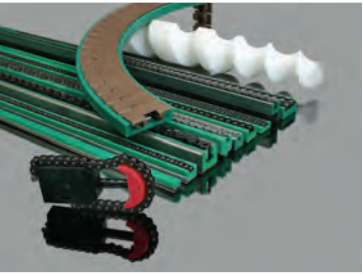

ÇAĞRI[®]
ENDÜSTRİ A.Ş.

ALHAN[®]



Davutpaşa Cad. Nu: 14/1
34010 Topkapı - İSTANBUL - TÜRKİYE
Tel: +90 212 444 00 42 - 544 50 55
Belgegeçer (Fax): +90 212 567 14 16 - 501 54 08
e-posta (e-mail) : info@alhan-cagri.com
www.alhan-cagri.com

YETKİLİ SATICI/DİSTRİBÜTÖR